

Installation Guide

Bacharach HGM300 to LonWorks FT-10 Communications Adapter

Introduction

The Bacharach HGM300 to LonWorks Communications Adapter enables an HGM300 Refrigerant Monitor to communicate with a LonWorks FT-10 Free Topology network. Zone PPM readings, flow status, refrigerant selections, and HGM internal health may be viewed over LonWorks. Each HGM zone supports three levels of alarming (Leak, Spill, Evacuate) and each alarm threshold can be set over LonWorks.

The LonWorks Communications Adapter can be used in conjunction with the RDM800 remote display if desired. Wiring details and operation limitations when using the RDM800 will be discussed later in this document.

Caution

The adapter is powered from the 120V Auxiliary Power connection on the HGM power supply board. When the HGM is powered up, 120V is present on the lower left corner of the adapter within the area shown on the board silkscreen. Keep fingers away from this area when the HGM is powered!!

Adapter Installation Inside HGM300

The communications adapter board will normally be installed in the HGM300 at the factory. It can, however, be field installed by following the instructions below.

The following installation materials are needed for field installation of the adapter:

- (5) 6-32 x ¼" screws (standard finish)
- (5) 6-32 x ½" threaded standoffs
- (5) 6-32 x ¼" decorative black anodized screws (standard finish OK, black looks nicer)

The adapter board mounts on the rear of the HGM300 door. Position the adapter board so as not to interfere with the HGM internal components when the door is shut. Mark (Figure 1) and drill the board's four corner holes and center hole in the door. Install the five standoffs on the rear side of the door using the five black decorative screws on the

FIGURE 1
HGM300 COMMUNICATIONS ADAPTER
MOUNTING TEMPLATE
USE 1/4" DIA, 6-32 THREADED STANDOFFS 1/2" LONG

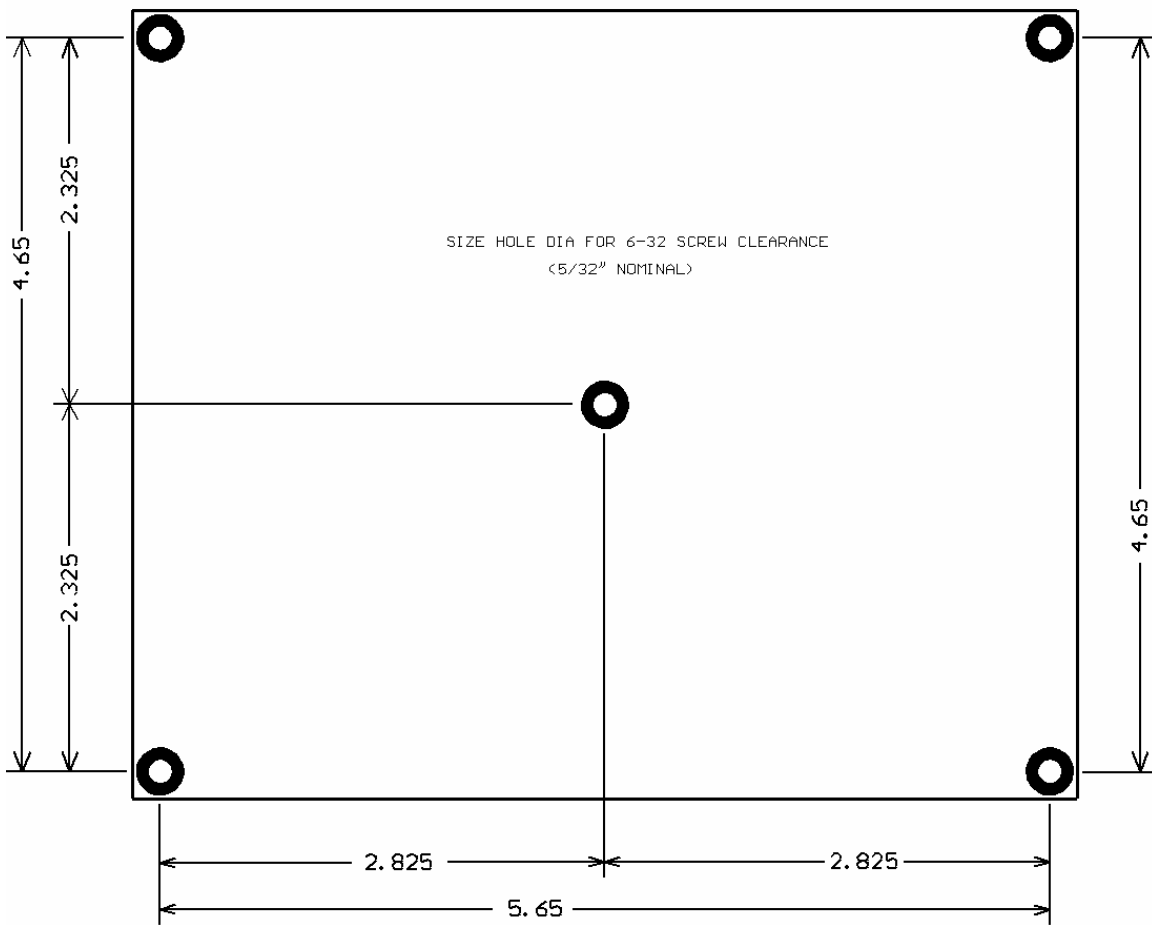

front side of the door. Position the adapter board over the standoffs mounted on the HGM door. Install the five remaining 6-32 screws through the board and into the standoffs and tighten.

Connect power wiring from the HGM300's 120V Auxiliary Power terminal block to the adapter board's POWER terminal block. Use UL approved wire. Wire polarity does not matter.

If an RDM800 remote display is NOT used with the adapter, refer to Figure 2 for wiring details. In this case, all wiring between the HGM300 main board and adapter is contained within the HGM300 and the only external cable is the LonWorks FT-10 communications cable.

FIGURE 2

HGM300-to-Lonworks Communications Adapter Wiring without RDM800 Remote Display

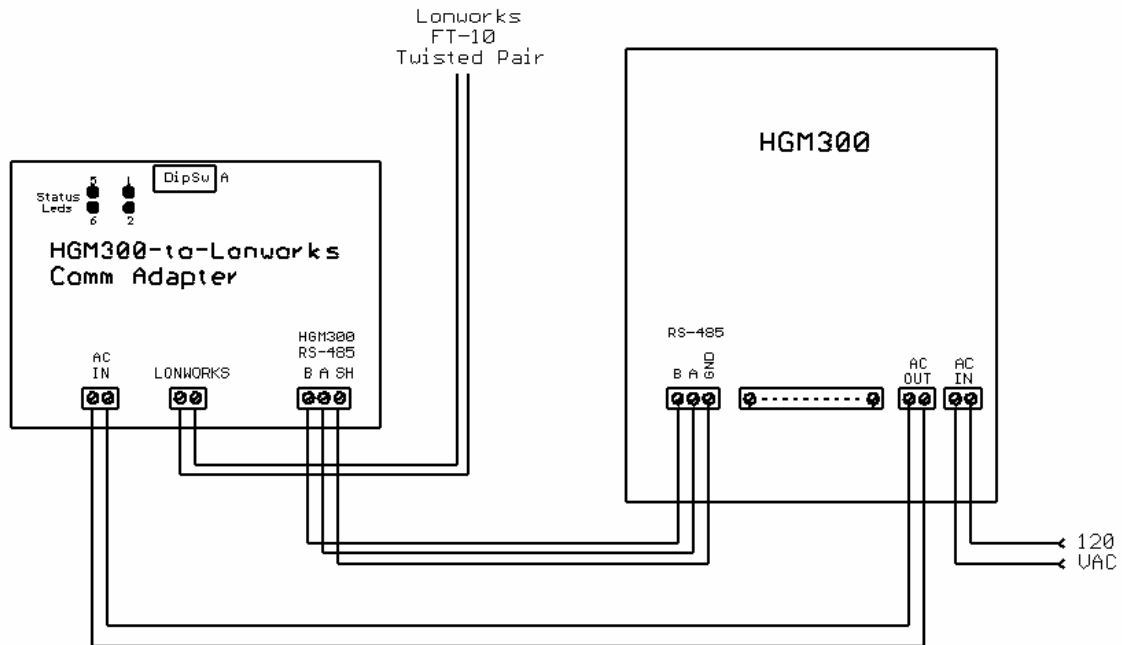

If an RDM800 remote display IS to be used with the adapter, refer to Figure 3 for wiring details. Note that when the RDM800 is used, TWO RS-485 cables must be run between the HGM300 and RDM800, so plan accordingly.

In either case, be sure to set the HGM300's internal "Terminator" slide switch next to the RS-485 terminal block to the "In" position.

FIGURE 3
HGM300-to-Lonworks Communications Adapter
Wiring with RDM800 Remote Display

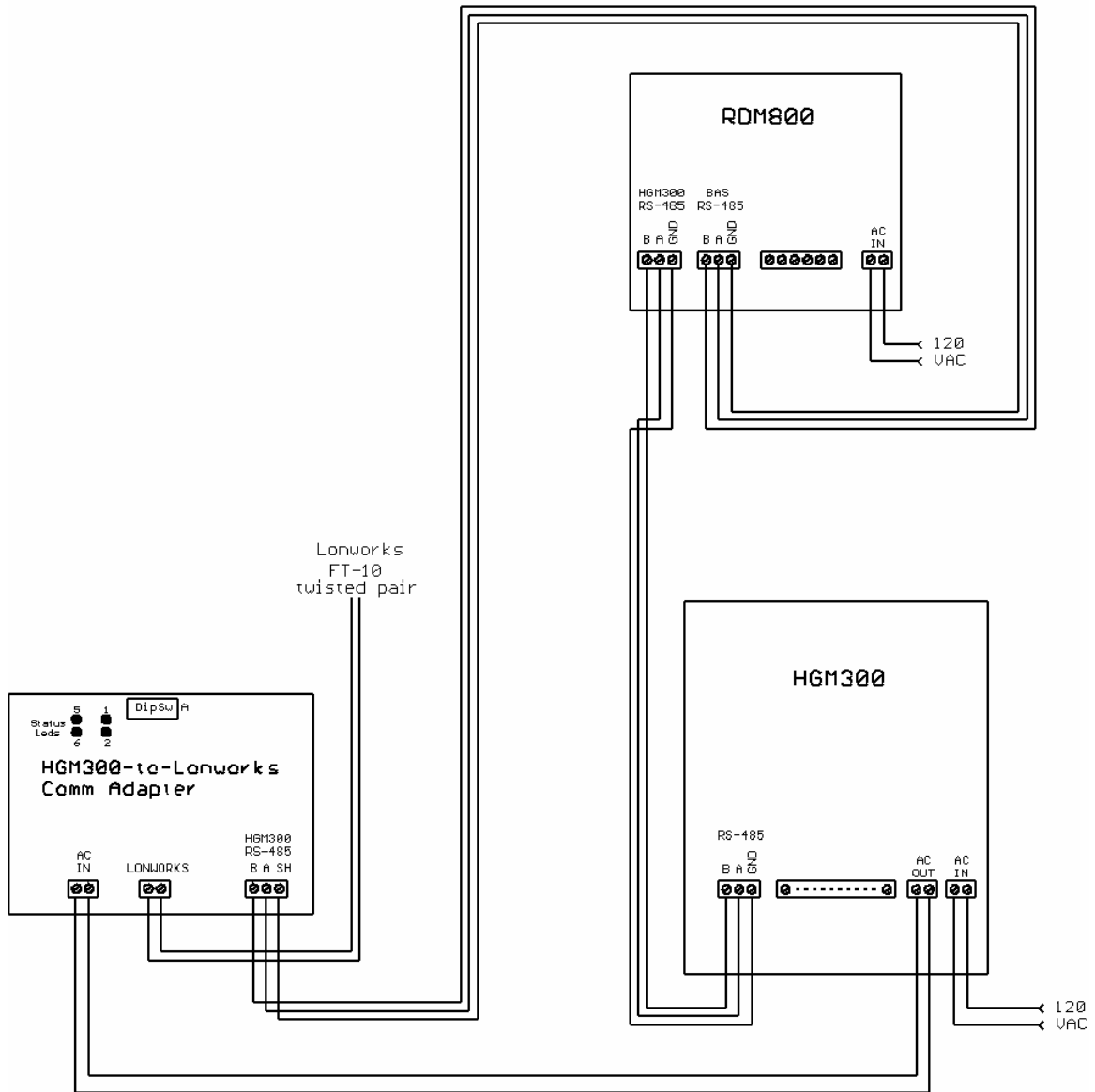

Setting HGM Communication Address On Adapter

See Figure 4 for the location of adapter dipswitch 'A'.

Switches 5-8 on the adapter's 'A' dipswitch are used to match the node address set on the HGM's address dipswitch (on HGM main board). Values from 0-15 are possible:

HGM address	A5	A6	A7	A8
0	Off	Off	Off	Off
1	Off	Off	Off	On
2	Off	Off	On	Off
3	Off	Off	On	On
4	Off	On	Off	Off
5	Off	On	Off	On
6	Off	On	On	Off
7	Off	On	On	On
8	On	Off	Off	Off
9	On	Off	Off	On
10	On	Off	On	Off
11	On	Off	On	On
12	On	On	Off	Off
13	On	On	Off	On
14	On	On	On	Off
15	On	On	On	On

Since the HGM is the only node on the adapter-to-HGM interface, address 1 is normally used. Be sure to set the same address on the adapter and the HGM main board dipswitches.

FIGURE 4 HGM300-to-Lonworks Adapter Dipswitch and LED indicators

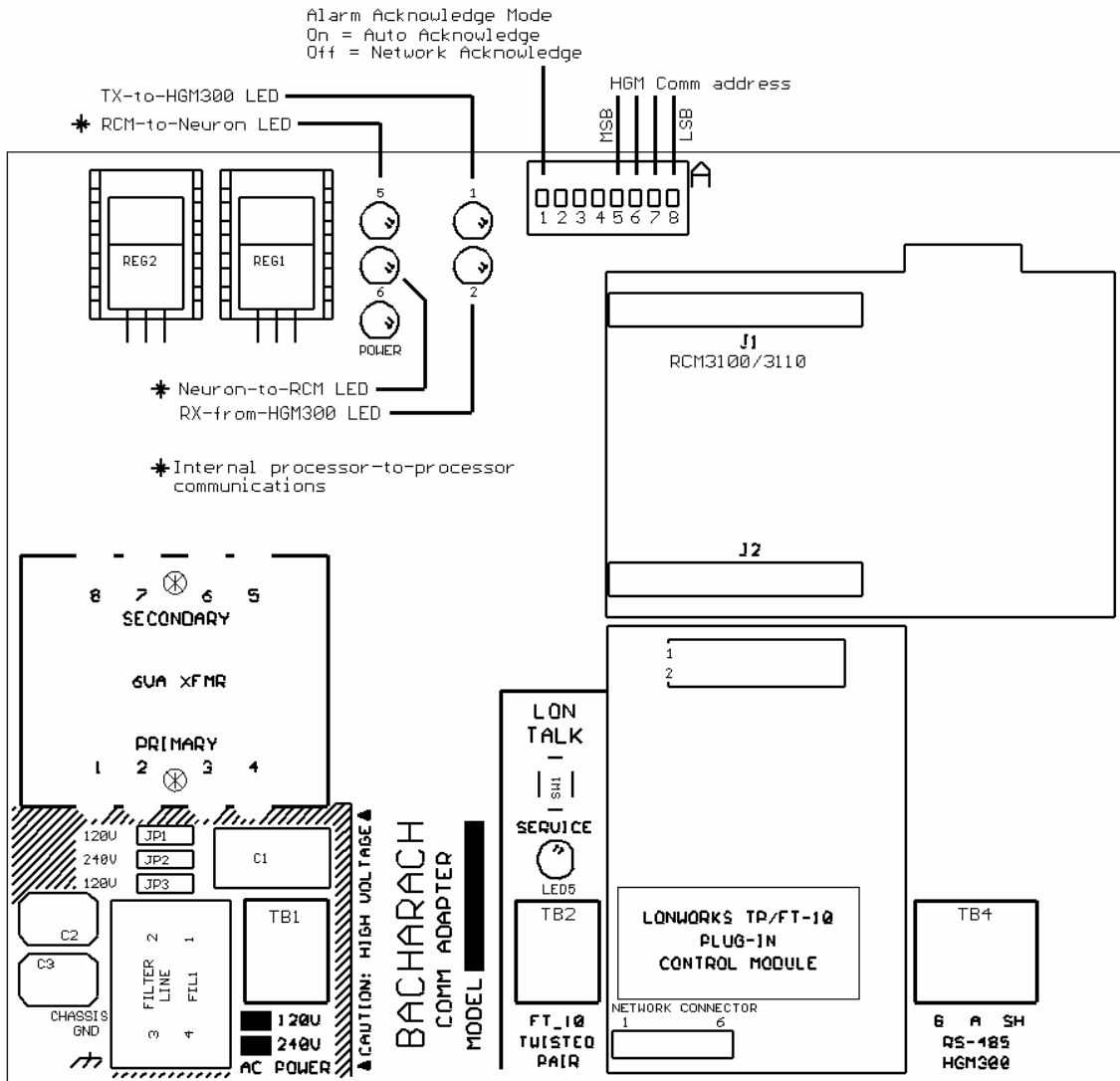

Configuring the HGM300 with RDM800 or Laptop PC

The only HGM parameters that are changeable through LonWorks are the alarm thresholds. Configuring the HGM for refrigerant type and length of tubing for each zone (zero length to disable a zone) must be done with the RDM800 remote display or a laptop PC. Refer to the appropriate Bacharach instructions for configuring these items. HGMs are commonly custom-configured at the factory per the customer's needs, so field configuring these parameters may not be necessary.

If configuring the HGM with an RDM800, the communications adapter's presence will not affect the standard configuration procedure. If configuring with a laptop PC, temporarily disconnect the HGM300's RS-485 cable from the adapter until configuration is complete and the laptop is disconnected.

External Interface (XIF) and User Resource Files

Each adapter comes with a disk containing an External Interface (XIF) and User Resource files. The files contain documentation about the network variables contained in the adapter and how they are used. Most network management software will accept XIF files. Echelon LonMaker (and possibly others) will accept User Resource files. A subset of the information in these files is permanently stored in the adapter itself and may be queried over the network once the network management software is aware of the node's presence.

Identifying the HGM300-LonWorks Adapter on the Network

The adapter can be identified on the network in three ways:

1. If the network management software supports identification by Service Pin, the adapter's Service pushbutton (directly above the FT-10 twisted pair terminal block) can be pushed when the network management software requests it. This causes a "here I am" message to be broadcast which should be received by the network manager.
2. The adapter's Neuron chip ID number can be entered manually into the network control PC or handheld tool when requested by the network management software. The Neuron chip ID number is written on the piggyback LonWorks control module in the format XX-XX-XX-XX-XX-XX.
3. If the network management software is capable of finding unconfigured nodes automatically, the Wink command can be sent to the ID of each unconfigured node. Then the nodes can be physically checked to see which node corresponds to which address. When the adapter receives a LonWorks Wink command, it flashes its 1, 2, 5, and 6 Status LEDs in unison for approximately 15 seconds.

HGM Alarm Acknowledge Options

Two alarm acknowledge options are supported—Auto Acknowledge and Network Acknowledge.

In the Auto Acknowledge mode, the HGM will clear its alarm outputs the next time the alarmed zone is sampled and its PPM has dropped below the alarm thresholds. No intervention from the LonWorks network is necessary.

In the Network Acknowledge mode, the HGM will never clear its alarm outputs until LonWorks has acknowledged the alarms using network variables `nviHgmAlmAck` or `nviHgmAlmAckSw` (discussed below). Once LonWorks has acknowledged the alarms, the HGM will clear its alarm outputs the next time the alarmed zone is sampled and its PPM has dropped below the alarm thresholds.

Dipswitch A1 on the adapter selects which alarm acknowledge option is used:

A1 On = Auto Acknowledge

A1 Off = Network Acknowledge

If dipswitch A1 is changed while the adapter is powered up, the adapter must be reset by pressing the CPU RST button below dipswitch A before the change will take effect.

LonWorks Objects and Network Variables

The adapter contains one Node Object, sixteen Zone Objects, one General Status Object, and one Alarm Control Object. There is one Zone Object for each refrigerant sampling zone.

Object 0 – The Node Object

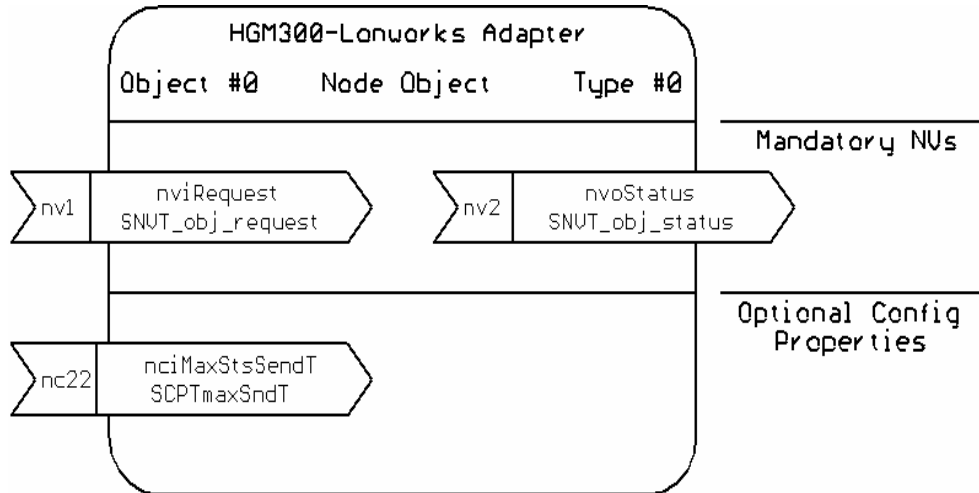

Network input variable nviRequest allows the user to request information from different objects in the node. The nviRequest contains an object ID field that specifies which object receives the request. The following request types are supported:

1. **RQ_NORMAL** (value 0) – This request is accepted by any of the objects for compatibility with LonMark requirements, but the request does not cause any change in the objects whatsoever. It does cause the status of the specified object to be reported through nvoStatus (works identically to RQ_UPDATE_STATUS).
2. **RQ_UPDATE_STATUS** (value 2) – Requests the status of the object specified in the object ID field. If sent to the Object Node (Node 0), the status response contains the status bits of all the node objects logically ORed together. The status response is returned through nvoStatus.
3. **RQ_REPORT_MASK** (value 5) – Requests the object to report which status bits it supports. All objects support the same status bits, thus the report mask returns the same value no matter which object is requested. These are the status bits supported:

- mechanical_fault (for no flow or excessive HGM internal temperatures)
- electrical_fault (for HGM internal electrical faults)
- unable_to_measure (any time can't get HGM data for whatever reason)
- comm_failure (HGM-to-adapter failure or adapter internal failure)
- in_alarm (when sampled PPM exceeds an alarm threshold on any zone)

Network output variable nvoStatus returns the information requested by nviRequest. The status response will indicate the status of the object that received the request. The status bits supported are listed above under RQ_REPORT_MASK.

One nvoStatus response will be returned for each nviRequest. The **configuration variable nciMaxStsSendT** can also be used to automatically send out status updates periodically. If nciMaxStsSendT is set to a nonzero time value, the node sends out a status update on each expiration of that amount of time. It rotates through the objects on the node in round-robin fashion when timed updates are sent in this manner. Any zone which is disabled or not installed will have its zone object skipped in this automatic round-robin reporting.

Setting nciMaxStsSendT to a very small value will cause unnecessary traffic on the LonWorks network. A value of less than 500 milliseconds will, in fact, be ignored. A suggested value for nciMaxStsSendT might be in the range of 10-60 seconds. If timed automatic status updates are not desired, set nciMaxStsSendT to zero. Then status updates will only be sent in response to nviRequest updates.

Objects 1-16 – Zone Objects

There is one Zone Object for each sampling zone in the HGM300 (16 total):

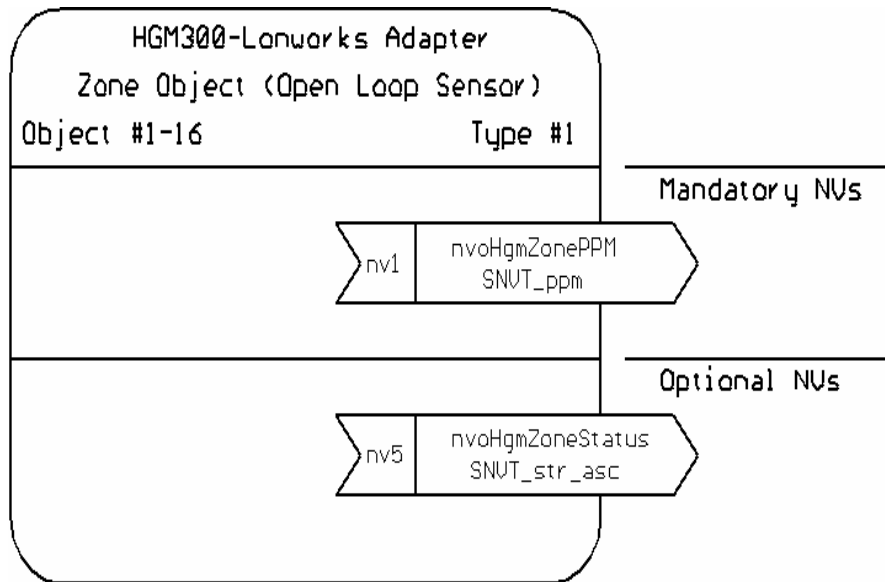

Network output variable nvoHgmZonePPM shows the measured gas concentration for a particular zone. The value will range from 0-65535 PPM.

Network output variable nvoHgmZoneStatus is a text string that displays information about the zone status and the refrigerant type being sensed.

Possible Zone Status values:

ZONE NORMAL

No alarms, no faults, HGM in normal operating mode.

LEAK ALARM

Leak alarm active for this zone.

SPILL ALARM

Spill alarm active for this zone.

EVAC ALARM

Evacuate alarm active for this zone.

ACKD LEAK ALM

Acknowledged Leak alarm active for this zone.

ACKD SPILL ALM

Acknowledged Spill alarm active for this zone.

ACKD EVAC ALM

Acknowledged Evacuate alarm active for this zone.

ZONE FLOW FAULT

This zone has a flow fault (other zones not affected).

CRITICAL FAULT

Some critical fault prevents normal zone PPM measurement.

(View nvoHgmFaults for details on fault type)

HGM BUSY

Occurs with RDM800 installed when certain screens are displayed.

COMM FAULT 1

Comm failure between HGM and adapter.

COMM FAULT 2

Comm failure between adapter internal processors.

HGM WARMING UP

HGM must go thru warmup cycle after powerup before measuring.

ZONE DISABLED

This zone has tubing length set = 0 (disabled).

NOT_INSTALLED

This zone does not have hardware installed in HGM.

STARTING UP

Startup delay after powerup before data available.

Possible Refrigerant Type values:

R11, R12, R22, R23, R113, R114, R123, R124, R134A, R401A, R402A, R402B,
R404A, R407A, R407C, R409A, R410A, R500, R502, R503, R507, R508B, H1301,
R408A, FUTURE2, FUTURE3, FUTURE4, FUTURE5, FUTURE6, FUTURE7,
NEW1, NEW2, NEW3

Object 17 – General Status Object

The General Status Object provides information about any HGM300 internal faults present and shows which zone is currently being sampled:

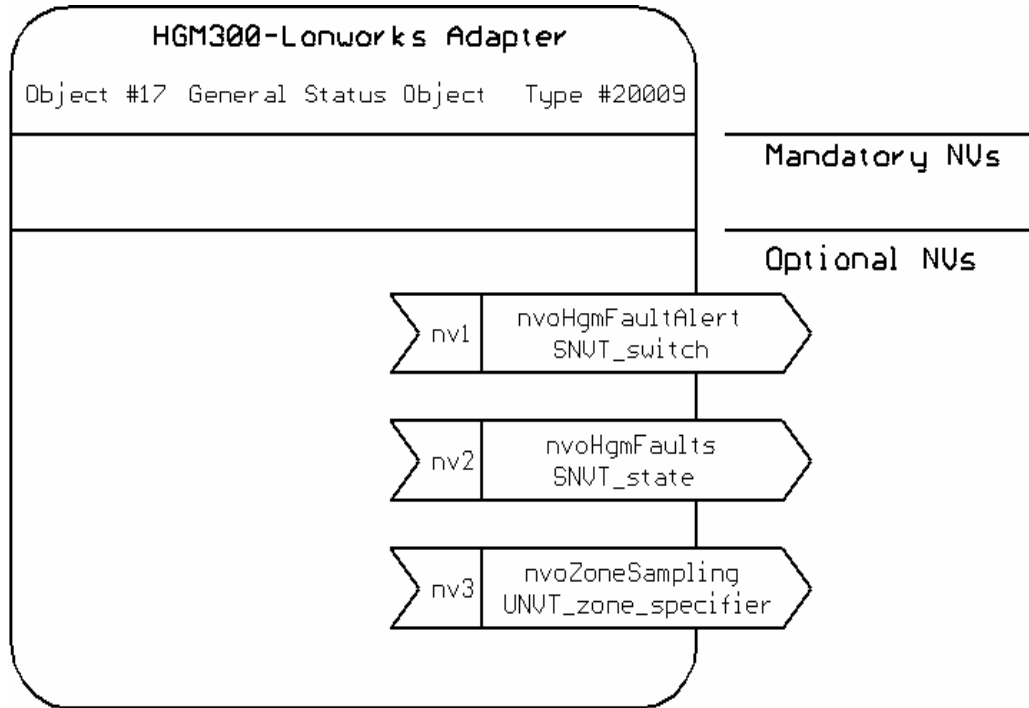

Network output variable nvoHgmFaultAlert reports whenever ANY fault is detected within the HGM or adapter. It is of type SNVT_switch. It is useful for binding to a Fault lamp on a remote annunciation panel using a network input variable of type SNVT_switch. When there is no fault, nvoFaultAlert will have value=0, state=0. When there is a fault, nvoFaultAlert will have value=200, state=1. Depending on the network presentation software, full-scale “value” may display as “200” or “100.0”.

Network output variable nvoHgmFaults (bit field structure) reports various faults within the HGM300 or the LonWorks adapter. It contains 14 faults (1-bit fields) that may be reported (0 = No Fault, 1 = Fault):

- Clipping fault (internal HGM measurement fault)(bit 15)(most significant bit)
- Zero Fault (internal HGM measurement fault)(bit 14)
- No Flow Fault (no flow on any zone)(bit 13)
- Purge Flow Fault (no flow during purge cycle)(bit 12)
- Zone Flow Fault (no flow on a particular zone)(bit 11)
- Trigger Fault (internal HGM measurement fault)(bit 10)
- No Zones Fault (no zones enabled in HGM)(bit 9)
- mA Loop Fault (mA loop output [option] is open circuited)(bit 8)
- Pressure Fault (HGM bench pressure abnormal)(bit 7)
- Bench Temp Fault (HGM bench temp abnormal)(bit 6)
- Box Temp Fault (HGM box temp abnormal)(bit 5)

HGM Busy (if RDM800 attached and showing certain screens)(bit 4)
Comm Fault 1 (communications failed between HGM and adapter)(bit 3)
Comm Fault 2 (internal communications failed within adapter)(bit 2)
Unused (bit 1)
Unused (bit 0)(least significant bit)

Network output variable nvoZoneSampling shows which zone is currently being sampled by the HGM. It is a number 1-16. Note that if fewer than 16 zones are installed, nvoZoneSampling will never go larger than the largest zone installed. Also if a zone is disabled (by setting its tubing length to zero), that zone number will be skipped by nvoZoneSampling.

Object 18 – Alarm Control Object

The Alarm Control Object provides information about any alarms which are present in the HGM. It also provides mechanisms for acknowledging alarms, and for viewing and setting the Leak, Spill, and Evacuate alarm thresholds for each zone:

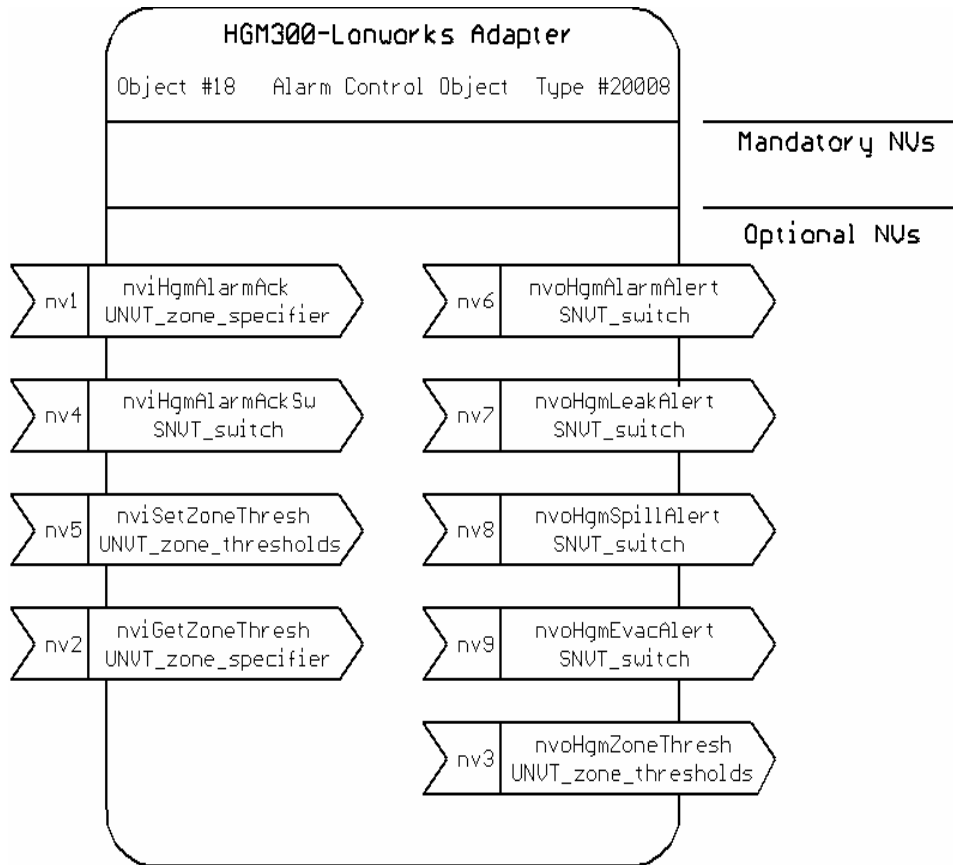

Network input variable nviHgmAlarmAck has a single parameter (unsigned short) which specifies which zone alarm the operator wishes to acknowledge. A value of 1-16 acknowledges the alarm for a single specified zone. A value of 0 is a global acknowledge for all zones in alarm.

Network input variable nviHgmAlmAckSw is a global alarm acknowledge of standard type SNVT_switch. It is useful for binding to an Acknowledge pushbutton on a remote alarm annunciation panel using a network output variable of type SNVT_switch. To acknowledge alarms, set nviHgmAlmAckSw to value=200, state=1. Depending on the presentation software, full-scale “value” may be “200” or “100.0”.

Network input variable nviSetZoneThresh allows Leak, Spill, and Evacuate alarm thresholds (in PPM) to be set for each monitoring zone. nviSetZoneThresh has four parameters to be set by the user:

Zone Specifier:

a number 1-16 specifies which zone is having its thresholds changed

Leak Alarm Threshold:

a number 0–65535 PPM

Spill Alarm Threshold:

a number 0-65535 PPM (larger than Leak Threshold)

Evacuate Alarm Threshold:

a number 0-65535 PPM (larger than Spill Threshold)

Network input variable nviGetZoneThresh accepts a single number 1-16 to specify which zone's alarm thresholds should be displayed on network output variable nvoHgmZoneThresh.

Network output variable nvoHgmAlarmAlert reports whenever ANY gas concentration alarm (Leak, Spill, or Evacuate) is generated by the HGM. It is of type SNVT_switch. It is useful for binding to an Alarm lamp on a remote annunciation panel using a network input variable of type SNVT_switch. When there are no alarms, nvoAlarmAlert will have value=0, state=0. When there is any alarm, nvoAlarmAlert will have value=200, state=1. Depending on presentation software, the full-scale "value" may show as either "200" or "100.0".

Network output variable nvoHgmLeakAlert reports whenever any Leak alarm is generated by the HGM. It is of type SNVT_switch. It is useful for binding to a Leak Alarm lamp on a remote annunciation panel using a network input variable of type SNVT_switch. When there are no Leak alarms, nvoLeakAlert will have value=0, state=0. When there are any Leak alarms, nvoLeakAlert will have value=200, state=1.

Network output variable nvoHgmSpillAlert reports whenever any Spill alarm is generated by the HGM. It is of type SNVT_switch. It is useful for binding to a Spill Alarm lamp on a remote annunciation panel using a network input variable of type SNVT_switch. When there are no Spill alarms, nvoSpillAlert will have value=0, state=0. When there are any Spill alarms, nvoSpillAlert will have value=200, state=1.

Network output variable nvoHgmEvacAlert reports whenever any Evacuate alarm is generated by the HGM. It is of type SNVT_switch. It is useful for binding to an Evacuate Alarm lamp on a remote annunciation panel using a network input variable of type SNVT_switch. When there are no Evacuate alarms, nvoEvacAlert will have value=0, state=0. When there are any Evacuate alarms, nvoEvacAlert will have value=200, state=1.

Network output variable nvoHgmZoneThresh displays the following information for the zone specified by nviGetZoneThresh:

1. Zone (1-16) whose alarm thresholds are being displayed
2. Leak Alarm Threshold in PPM (0-65535)
3. Spill Alarm Threshold in PPM (0-65535)
4. Evacuate Alarm Threshold in PPM (0-65535)

To change the Leak, Spill, or Evacuate alarm thresholds for a zone, use the nviSetZoneThresh input network variable as described earlier.

Operating Limitations When Using RDM800 Remote Display

When an RDM800 remote display is used, LonWorks will have access to the HGM300 as long as the RDM800 is in either the SYSTEM or ZONE VIEW screen. If the RDM800 is set to display any other screen, it will respond to polls from the LonWorks adapter with an HGM BUSY exception code. The LonWorks adapter will handle the exception by setting all the zone statuses = HGM BUSY. When the RDM800 is returned to the SYSTEM or ZONE VIEW screen, normal LonWorks monitoring will resume.

If the operator leaves the RDM800 in some screen other than SYSTEM or ZONE VIEW for an extended period of time (10 minutes default), the RDM800 times out and automatically returns to either the SYSTEM or ZONE VIEW screen. This will restore normal LonWorks monitoring.

Communications LED Indicators

See Figure 4 for the locations of the communications LED indicators.

The communications adapter board has four LED communications status indicators numbered 1-4. The meanings of these indicators are as follows:

- LED 1 ON: Adapter is transmitting a poll/command to the HGM300
- LED 2 ON: Adapter is receiving a response from the HGM300
- LED 5 ON: Adapter internal communications (response from RCM CPU to Neuron CPU)
- LED 6 ON; Adapter internal communications (poll/command from Neuron CPU to RCM CPU)

Under normal conditions, LEDs 5 and 6 will show a burst of alternating blinks about every 8 seconds. This indicates that the two processors internal to the LonWorks adapter are communicating with each other normally. Occasionally LEDs 5 and 6 will blink more frequently if commands (to change alarm thresholds, for example) are coming in from the LonWorks network.

LED 1 and LED 2 will normally show activity about every 15 seconds. Since the refrigerant monitoring process is fairly slow and new data is only available every 15 seconds or so, the adapter polls the HGM at a slow rate to reduce the communications burden on the HGM main processor. Again, commands coming in from LonWorks might occasionally cause LEDs 1 and 2 to blink more frequently.

Operating Notes

Before changing alarm thresholds through `nviSetZoneThresh`, go ahead and set `nviGetZoneThresh` to the zone you are about to modify. Then `nvoHgmZoneThresh` will update automatically with the current thresholds for that zone every time new information is available from the HGM300.

Please note that it could take as much as 30-40 seconds before the changes made through `nviSetZoneThresh` can be seen on `nvoHgmZoneThresh`. The adapter must get the changes from LonWorks and pass the new thresholds down to the HGM. The HGM then takes a certain amount of time to process the changes and store them in its nonvolatile memory. Then, since the HGM is not polled continuously, a certain amount of time is needed to pick up the new threshold settings and pass them back up to LonWorks. Please be patient waiting for changed alarm thresholds to show up in `nvoHgmZoneThresh`. Fortunately changing alarm thresholds is done infrequently after initial installation and setup.

If the adapter is moved to a new LonWorks network where the old addressing information would be invalid, the adapter can be set back to its initial Unconfigured state. This is accomplished by holding the Service button down, powering up the adapter, and continuing to hold the Service button down for 10 seconds. When the Service button is released, the Service LED will flash, showing that the LonWorks portion of the adapter is now Unconfigured. This is the desired state for installing the adapter on a new LonWorks network.