

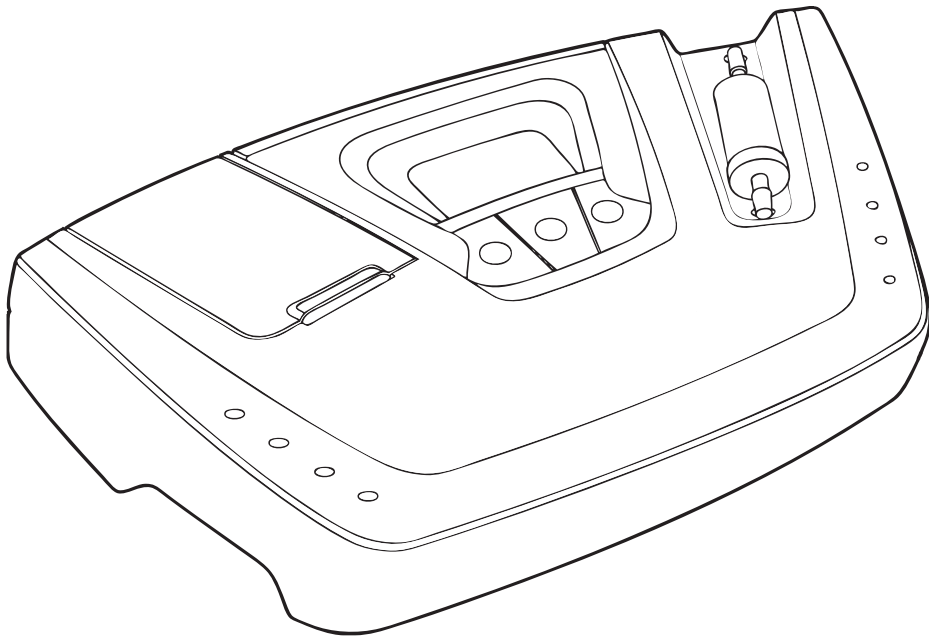

PUR·CHEKTM
HVAC Refrigerant Analyzer

Instruction 2100-9000
Operation and Maintenance

Rev. 0 — June 2010



WARRANTY

Bacharach, Inc. warrants to Buyer that at the time of delivery this Product will be free from defects in material and manufacture and will conform substantially to Bacharach Inc.'s applicable specifications. Bacharach's liability and Buyer's remedy under this warranty are limited to the repair or replacement, at Bacharach's option, of this Product or parts thereof returned to Seller at the factory of manufacture and shown to Bacharach Inc.'s reasonable satisfaction to have been defective; provided that written notice of the defect shall have been given by Buyer to Bacharach Inc. within one (1) years after the date of delivery of this Product by Bacharach, Inc.

Bacharach, Inc. warrants to Buyer that it will convey good title to this Product. Bacharach's liability and Buyer's remedy under this warranty of title are limited to the removal of any title defects or, at the election of Bacharach, to the replacement of this Product or parts thereof that are defective in title.

The warranty set forth in paragraph 1 does not apply to parts the Operating Instructions designate as having a limited shelf-life or as being expended in normal use (e.g., filters).

THE FOREGOING WARRANTIES ARE EXCLUSIVE AND ARE GIVEN AND ACCEPTED IN LIEU OF (I) ANY AND ALL OTHER WARRANTIES, EXPRESS OR IMPLIED, INCLUDING WITHOUT LIMITATION THE IMPLIED WARRANTIES OF MERCHANTABILITY AND FITNESS FOR A PARTICULAR PURPOSE: AND (II) ANY OBLIGATION, LIABILITY, RIGHT, CLAIM OR REMEDY IN CONTRACT OR TORT, WHETHER OR NOT ARISING FROM BACHARACH'S NEGLIGENCE, ACTUAL OR IMPLIED. The remedies of the Buyer shall be limited to those provided herein to the exclusion of any and all other remedies including, without limitation incidental or consequential damages. No agreement varying or extending the foregoing warranties, remedies or this limitation will be binding upon Bacharach, Inc. unless in writing, signed by a duly authorized officer of Bacharach.

Register Your Warranty by Visiting

www.mybacharach.com

Notice:

Product improvements and enhancements are continuous; therefore the specifications and information contained in this document may change without notice.

Bacharach, Inc. shall not be liable for errors contained herein or for incidental or consequential damages in connection with the furnishing, performance, or use of this material.

No part of this document may be photocopied, reproduced, or translated to another language without the prior written consent of Bacharach, Inc.

Copyright © 2010, Bacharach, Inc., all rights reserved.

BACHARACH® is a registered trademark of Bacharach, Inc. All other trademarks, trade names, service marks and logos referenced herein belong to their respective owners.

Contents

1 Introduction.....	1
1.1 How to Use This Manual	1
1.2 Warnings & Cautions.....	1
1.2.1 Analyzer Warnings.....	1
1.2.2 General Warnings & Cautions	2
1.3 Features and Capabilities.....	2
1.4 Pur•Chek™ Models and Contents.....	2
1.5 Functional Overview	3
2 Specifications	4
3 Components.....	5
3.1 Base Unit.....	5
3.2 R12 Sample Hose	5
3.3 AC Power Adapter	5
3.4 Control Panel.....	6
3.5 Back Panel Connections	6
3.6 Hard Shell Storage/Carrying Case	7
4 Operation.....	8
4.1 Battery Installation	8
4.2 Turning On the Unit	9
4.3 Calibration	9
4.4 Viewing the Test Results	10
4.5 Blend Refrigerants.....	10
4.6 Printing the Test Results.....	11
5 Maintenance & Troubleshooting	12
5.1 Setting the Elevation.....	12
5.2 Setting the LCD Contrast.....	12
5.3 Changing the Sample Filter.....	13
5.4 Cleaning the Sample Hoses.....	13
5.5 Changing the Printer Paper.....	13
5.6 Low Battery Warning	14
5.7 Error Messages	14
6 Replacement Parts	15
7 Service Centers	15

1 Introduction

1.1 How to Use This Manual

This manual provides important information on how to operate and maintain Bacharach's Pur•Chek™ HVAC Advanced Refrigerant Identifier.

To assure operator safety and proper use of the Pur•Chek™, please read, understand, and follow the contents of this manual.

1.2 Warnings & Cautions

When used in this manual or as labeled on the Pur•Chek™, the following hazard symbols and/or associated words are defined as follows:



WARNING: This symbol and/or the use of the word **WARNING** indicates a potential hazard associated with the use of this equipment. It calls attention to a procedure, practice, condition, or the like, which if not correctly performed or adhered to, could result in death or serious injury.



WARNING: This symbol and/or the use of the word **WARNING** indicates a potential hazard from electrical shock. It calls attention to a procedure, practice, condition, or the like, which if not correctly performed or adhered to, could result in death or serious injury.



CAUTION: This symbol and/or the use of the word **CAUTION** indicates a potential hazard associated with the use of this equipment. It calls attention to a procedure, practice, condition, or the like, which if not correctly performed or adhered to, could result in minor or moderate injury.

IMPORTANT: The use of the word **IMPORTANT** in this manual calls attention to a procedure, practice, condition, or the like, which if not correctly performed or adhered to, could result in incorrect performance of or damage to the equipment and may void the warranty.

1.2.1 Analyzer Warnings



Refrigerant Blend Warning: The HVAC industry is continually introducing new refrigerants. Many of these new blends can be profiled using the Pur•Chek™.



Sample Filter Warning: Replace the sample filter of the instrument AS SOON AS RED SPOTS OR DISCOLORATION BEGIN TO APPEAR ON THE OUTSIDE DIAMETER OF THE WHITE ELEMENT. Failure to properly maintain and replace the sample filter will result in severe damage.



Sample Input Warning: The instrument requires connection of the supplied sample hose to the LOW SIDE OR VAPOR port of refrigerant storage cylinders or air conditioning systems. DO NOT attempt to introduce liquid or samples heavily laden with oil into the low side sampling hose. DO NOT connect the sample hose to the HIGH SIDE or LIQUID port!

Damage caused to the instrument due to the use of the wrong hose on the wrong port will void the warranty.



Battery Charger Warning: When charging the optional battery with the 1000 mA charger, the charger will become warm. If the charger becomes hot, unplug the charger immediately! When charging multiple battery packs, allow the charger to cool between each battery.

1.2.2 General Warnings & Cautions

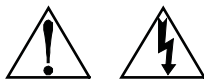

- Always inspect the sample hose before each use. Replace the hose if it appears cracked, frayed, obstructed or fouled with oil.
- ALWAYS turn the compressor off before connecting the instrument to an air conditioning system.
- Always wear eye and skin protection when working with refrigerants. Escaping refrigerant vapors will present a freezing danger.
- To reduce the risk of electrical shock, do not disassemble the instrument; do not use the instrument in wet or damp areas.
- DO NOT direct refrigerant vapors venting from hoses towards the skin.
- DO NOT disassemble the instrument. There are no serviceable components internal to the instrument and disassembly will void the warranty.
- ALWAYS place the Identifier on a flat and sturdy surface.
- DO NOT utilize any other hose other than those supplied with the instrument. The use of other hose types will introduce errors into the refrigerant analysis and instrument calibration.
- ALWAYS verify that the refrigerant to be tested does not contain or will not emit heavy loads of oil or liquid.
- NEVER admit any sample into the instrument at pressures in excess of 500 psig.

1.3 Features and Capabilities

The Pur•Chek™ HVAC Advanced Refrigerant Identifier is the most advanced portable instrument ever manufactured for determining the purity of gaseous refrigerants for the HVAC-R market. Features of the Pur•Chek™ include:

- Stable 4-gas infrared sensor technology
- Advanced ergonomic design
- Rugged rubberized hand grips
- Large graphic display with on-screen instructions
- Ultra fast 60-second test time
- 'Blend-Chek' software to identify the presence of R410A
- Built in printer option for instant analysis report
- Internal, rechargeable batter option for cordless operation in any location
- Hard shell carry/storage case

1.4 Pur•Chek™ Models and Contents

Model Name	Part Number	Contents
Pur•Chek™	2100-8001	Pur•Chek™ 2100-8001 1/4" Flare Sampling Hose Assembly 2100-0005 AC Adapter 2100-0004 Instruction Manual 2100-9000 All contained in a hard shell storage/carrying case.
Pur•Chek w/ Printer	2100-8002	Pur•Chek™ w/ Printer 2100-8002 1/4" Flare Sampling Hose Assembly 2100-0005 AC Adapter 2100-0004 Printer Paper (1 Roll)..... 2100-0003 Instruction Manual 2100-9000 All contained in a hard shell storage/carrying case.

1.5 Functional Overview

Contamination of refrigerants either in storage cylinders or air conditioning systems can lead to component corrosion, elevated head pressures and system failures when utilized by unsuspecting technicians. The ability of the technician to determine refrigerant type and purity is severely hampered by the presence of air when attempting to utilize temperature-pressure relations. The development of various substitute refrigerants further complicates the ability of a technician to identify refrigerant purity based upon temperature-pressure relationships. The substitute refrigerant blends can also introduce a flammability hazard to the technician and the ultimate end user of the air conditioning system.

The Bacharach Pur•Chek™ Advanced Refrigerant Identifier provides a fast, easy and accurate means to determine refrigerant purity in refrigerant storage cylinders or directly in air conditioning systems. The instrument utilizes non-dispersive infrared (NDIR) technology to determine the weight concentrations of refrigerant types R12, R134A, R22, as well as hydrocarbons. In addition, the unit will indicate the presence of R410A if the refrigerant tested matches the internal profile established for virgin R410A. Refrigerant purity is displayed on the LCD Screen. The user must determine acceptable levels of purity based on their recovery or use standards.

Sample gas is admitted into the instrument through the supplied sample hose and presented to the sensing device. The instrument provides the user with direct percent by weight concentrations of R12, R134A, R22 and hydrocarbons. If the sample is determined to be pure R134A, the instrument will provide a direct readout of the weight percentage of air within the sample. Note that the instrument does not consider air to be a contaminant since it can be removed by most refrigerant recycling equipment. Since air is not considered to be a contaminant, it is possible to read 100% R134A plus 5% air. The instrument only considers the weights of the refrigerant and contaminants in the total mixture for R134A as air contamination in R12 and R22 systems causes only minor performance degradation.

The instrument interfaces with the user with an LCD graphic display, status indicator lamps, push button communication switches and an alarm horn. Alarm indications are provided to alert of instrument fault conditions or contaminated refrigerant presence. Direct percent by weight concentrations of the sample refrigerant is provided on the display as well as user directions and prompts. An optional factory-installed printer (Model 2100-8002) is available to print an on-the-spot analysis report.

The Bacharach Pur•Chek™ Advanced Refrigerant Identifier provides the refrigerant technician with excellent knowledge of refrigerant purity and protection against refrigerant contamination and potential flammability.

2 Specifications

Sample Parameters	Vapor only, oil-free, 300psig (2 MPa) max.					
Detected Compounds	R12, R134A, R22, Hydrocarbons, Air					
Sensor Technology	Non-Dispersive Infrared (NDIR)					
Refrigerant Sample Size	0.3 ounces (8.5 grams) per sample					
Power	110/220 VAC Power Adapter 12 - 15 VDC Battery Pack, 2 Amps max. (Optional)					
Operational Temperature	40 - 130 °F (4 - 54 °C)					
Blend Refrigerants	Displays R410A. Not suitable for R404A or R507A, as they are presented as R134A. Blend data shown below is for reference only at 70 °F and should be verified by the user with virgin refrigerant.					
<p>CAUTION: This unit has been calibrated to R410A. Specific results will vary by unit.</p> <p>The chart shown is for generic reference only.</p>	Blend	Det - 1	Det - 2	Det - 3	Det - 4	Non
	R401A	<10	<10	<89-95	0	0
	R401B	<10	<10	87-97	0	0
	R402A	<10	<8	75-95	<10	<20
	R402B	<10	<6	87-97	<10	<6
	R407C	70-90	<6	<5	10-25	15-35
	R408A	45-65	0	35-55	0	0
	R409A	<10	<15	75-95	0	0
	R502	50-70	0	30-50	0	0
	Fingerprint your own unit by testing virgin samples of various refrigerants and recording the results below for future reference.					
Blend	Det - 1	Det - 2	Det - 3	Det - 4	Non	
R401A						
R401B						
R402A						
R402B						
R407C						
R408A						
R409A						
R502						

3 Components

3.1 Base Unit

The Pur•Chek™ base unit houses the Graphic Display, Infrared Bench, Electrical Connections, and Optional Printer Module. These components require no maintenance, therefore **there are no serviceable components internal to the instrument, and disassembly will void the warranty.**

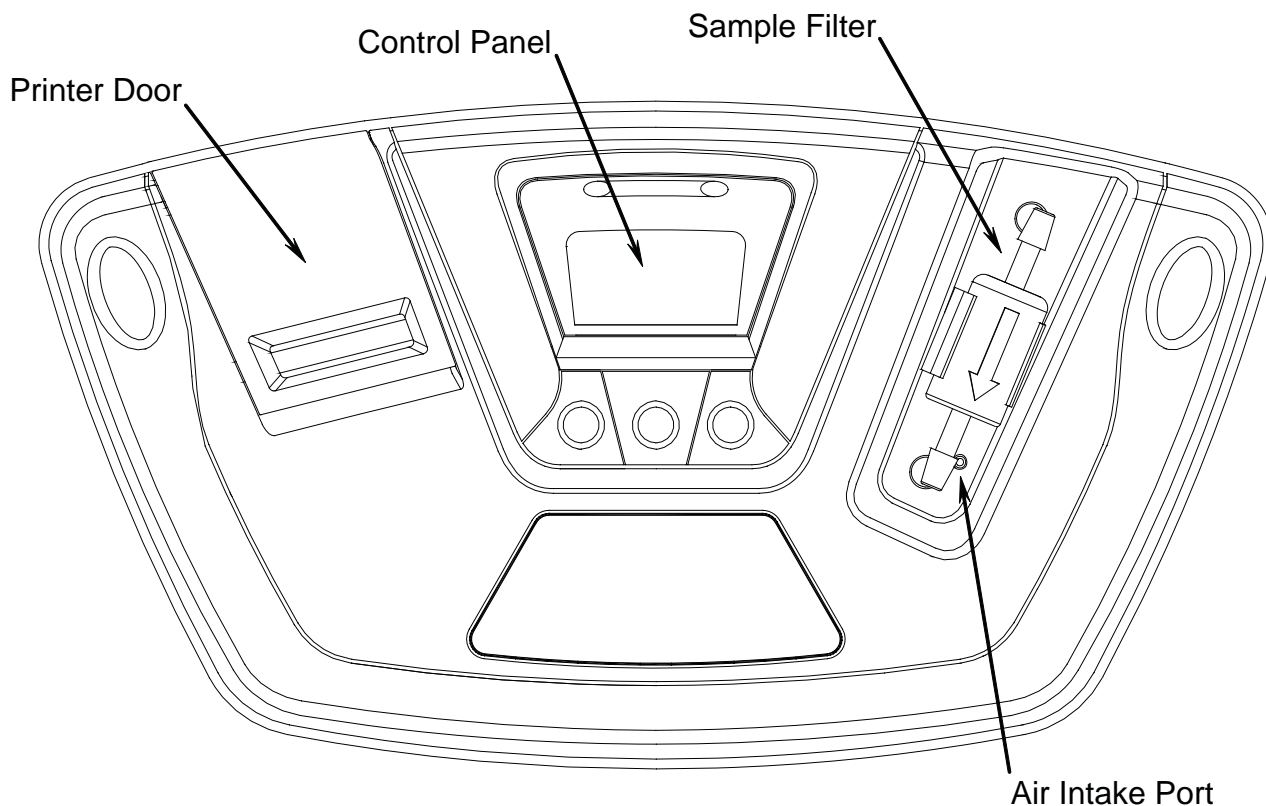

3.2 R12 Sample Hose

The 6-foot (1.8 meter) R12 Sample Hose is constructed of a nylon inner tube and a polyurethane outer tube. The inner tube will handle all of the refrigerant transfer and will provide containment up to 300psig. The outer tube will provide protection of the inner tube from abrasion, nicking, cutting, etc. The hose is provided with an instrument inlet port mating connector on one end and a 1/4" SAE female flare coupling nut on the service end.

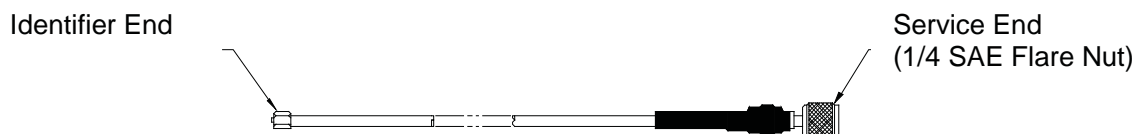

3.3 AC Power Adapter

The Pur•Chek™ is powered via a 110/220 VAC power transformer. This transformer is included with each unit and converts a standard 110/220 wall outlet to 12 VDC to power the device. An optional internal and rechargeable battery kit is available separately. Note: Use of any other power source may cause damage to the unit and void the warranty.

3.4 Control Panel

The Control Panel serves as the main user interface. The Control Panel features three soft key buttons that change their function as the instrument changes modes. The current function for each button is displayed by the soft key label at the bottom of the graphic display. Red and Green LED's at the top of the Control Panel are used for visual status indications.

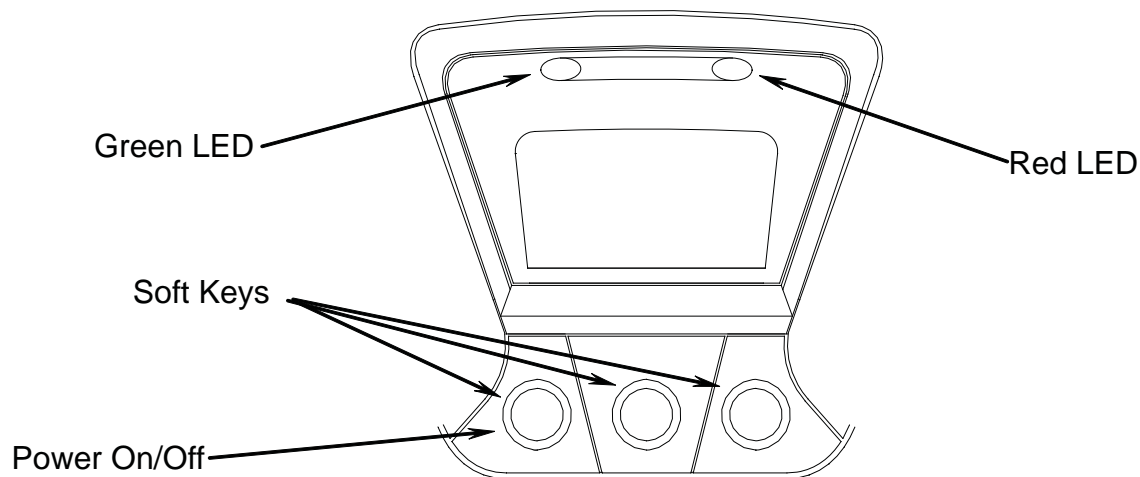

3.5 Back Panel Connections

The connections located on the back panel are illustrated below.



CAUTION: The sample outlet port should never be obstructed. Keep the sample outlet port free and clear at all times.

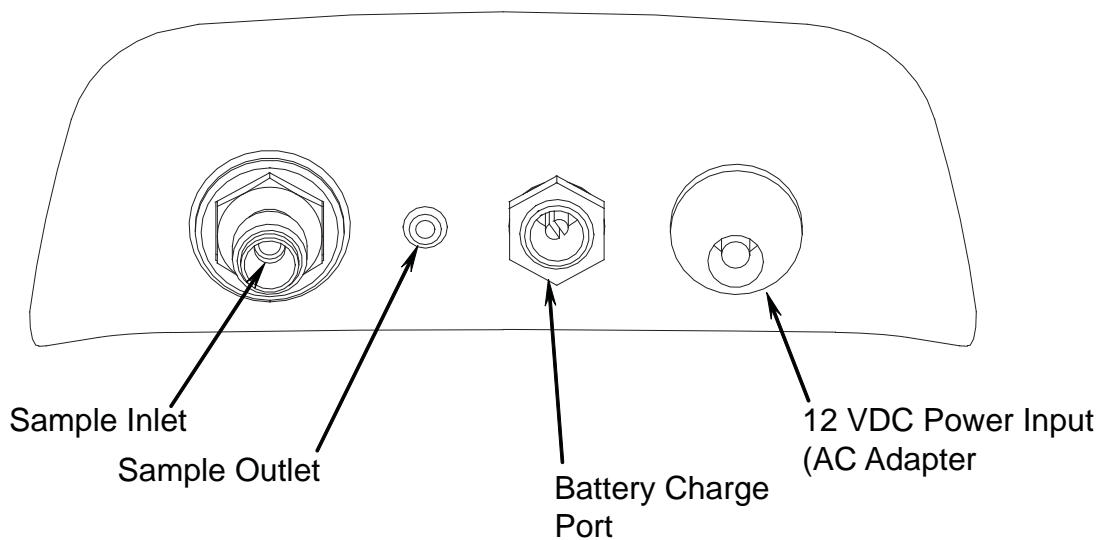

3.6 Hard Shell Storage/Carrying Case

The hard shell storage/carrying case is custom fit to the Pur•Chek™. It provides rugged protection for the instrument as well as convenient storage for all components. The enclosure is general purpose and is not watertight.

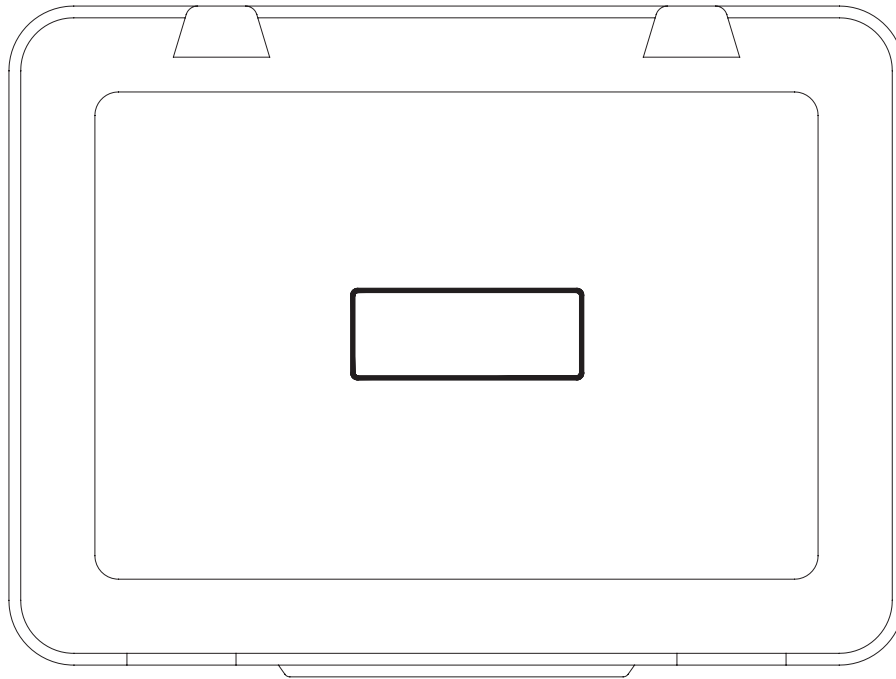

4 Operation

4.1 Battery Installation

The Pur•Chek™ has, as an option, an internal rechargeable battery. If your Pur•Chek™ is equipped with the optional rechargeable battery, you must first install and charge the battery prior to use. **NOTE:** The Pur•Chek™ can be operated with or without the battery using the supplied AC adapter. Refer to Section 2.2 for instructions.

To install the optional battery, remove the battery cover from the back of the unit by unscrewing the two Phillips head screws as shown below.

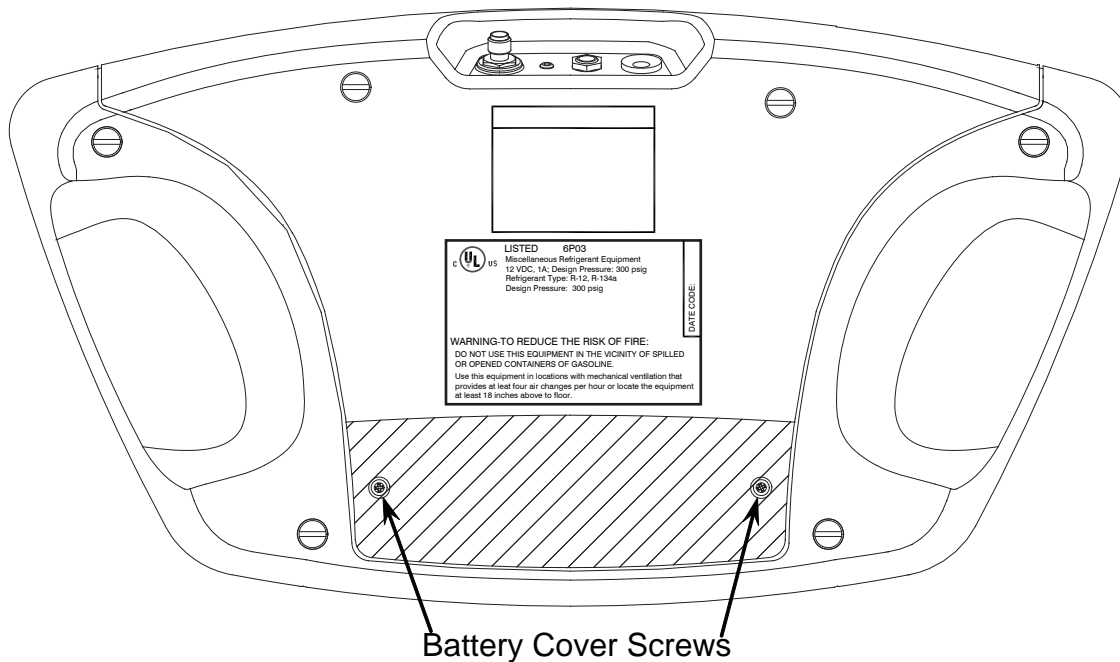

Inside the Pur•Chek™ battery compartment, locate the male plug on the left side. Slide the nylon strap around the battery. Insert the battery module into the compartment aligning the female connector of the battery module with the male plug in the battery compartment. Replace the cover and snug the screws.

NOTE: Charge the battery for a minimum of 4 hours with the supplied charger prior to first use.

To remove the battery, simply tug gently on the nylon strap, being sure to pull straight up, until the battery is dislodged. The battery may be charged either inside of the unit or independent of the unit.

4.2 Turning On the Unit

Connect the included AC power supply to the 12 VDC power input jack on the back of the unit. Plug in the AC power supply to a 110/220 240 VAC outlet.

NOTE: If the optional battery module is installed and charged, the AC power supply is not required.

Press the left, soft key, power button and the splash screen shown in Figure 1 will appear for approximately three seconds followed by the elevation screen shown in Figure 2. See section 5.1 for details on setting the elevation. Depressing the "DONE" button will bring the Pur•Chek™ to the Calibration screen as shown in Figure 3.

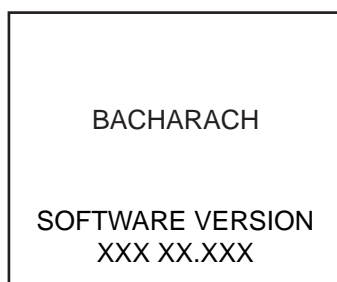

Figure 1.

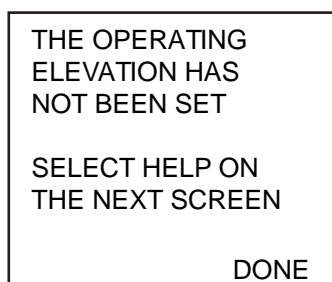

Figure 2.

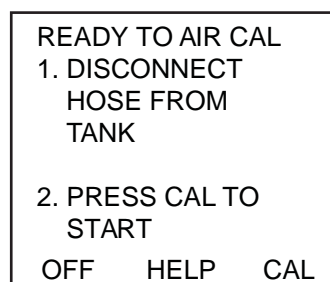

Figure 3.

4.3 Calibration

Each time the Pur•Chek™ begins a new test cycle it must first self calibrate. The calibration takes 30 seconds (Figure 4) and brings fresh air into the unit via an internal pump. This fresh air purges any excess refrigerant from the unit and ensures accurate test results. Calibration requires that the hose be disconnected from the refrigerant cylinder or air conditioning system. During calibration, the screen shown in Figure 5 will appear reminding the user to change the filter under certain conditions. For additional details on how and when to change the filter, refer to Section 5, Maintenance and Troubleshooting. The calibration of the unit will expire after approximately five minutes of inactivity. If this occurs, the screen shown in Figure 6 will be displayed requiring the calibration to be initiated again.

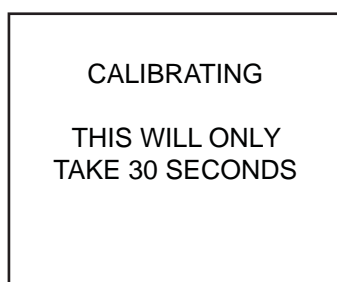

Figure 4.

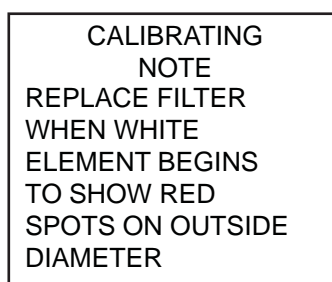

Figure 5.

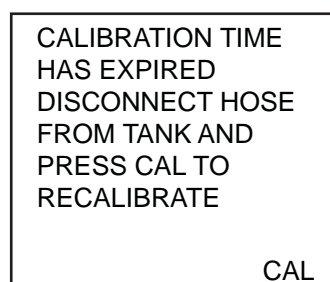

Figure 6.

After calibrating, the unit will display the screen shown in Figure 7. Connect the hose to the tank and press test. The Pur•Chek™ will display the screen shown in Figure 8. If you wish to change any of the factory default settings, refer to section 5.

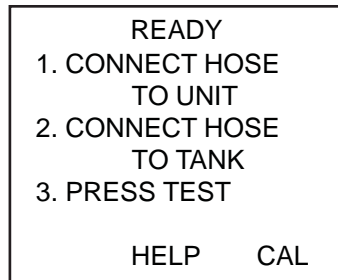

Figure 7.

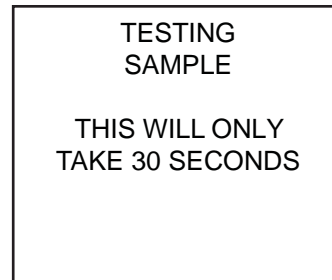

Figure 8.

4.4 Viewing the Test Results

Upon completion of the test, the Pur•Chek™ will display a screen similar to that shown in Figure 9 or Figure 10.

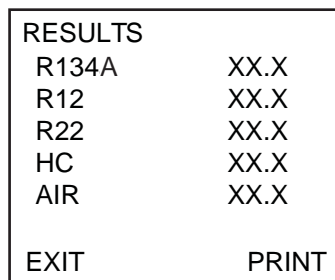

Figure 9.

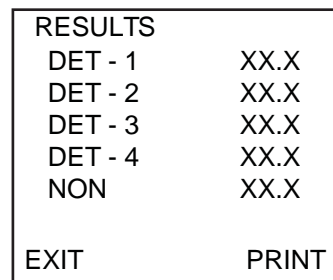

Figure 10.

If the refrigerant tested is 90% pure or better, the results will be displayed as shown in Figure 9. Should the refrigerant be less than 90% pure the results will be displayed as shown in Figure 10.

NOTE: Air is only displayed for R134A and only when the R134A refrigerant concentration is greater than 90%. "NON" represents non-condensable elements, such as air or another diluting gas.

4.5 Blend Refrigerants

The Pur•Chek™ includes the 'Blend Chek' feature for determining the presence of R410A. In the event that the Pur•Chek™ determines that the refrigerant in the system or cylinder is likely to be R410A, the results will display as follows in Figures 11. Pressing the "MORE" button will display the R410A screen shown in Figure 12. If the Blend is not recognized, the screen shown in Figure 13 will be displayed. Note: Please refer to Section 2, Specifications, for a list of known blends and cautions regarding test results.

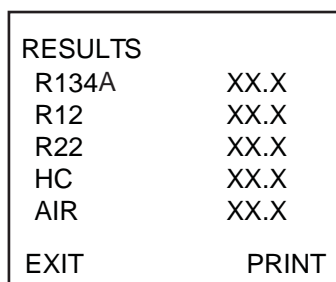

Figure 11.

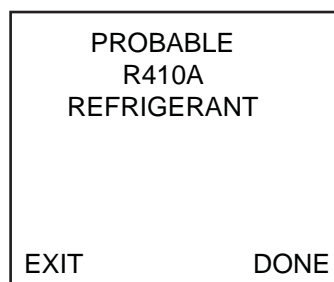

Figure 12.

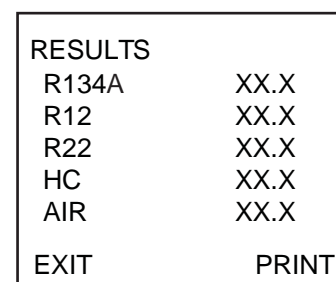

Figure 13.

Pressing the "EXIT" button in Figure 12 will return the user to the screen shown in Figure 11.

4.6 Printing the Test Results

For units equipped with the optional factory-installed printer module, the test results can be printed by selecting the “PRINT” button. After the print is complete, carefully tear off the printout and the unit will return to the previous screen. Additional printouts may be made following the same procedure. To exit the test, press the “EXIT” button. Figures 14, 15, & 16, show sample printouts for various test results.

Bacharach Inc. Refrigerant Identifier	
R134a	.0
R12	.0
R22	100.0
HC	.0

(Date)	

(Technician)	

Figure 14.

Bacharach Inc. Refrigerant Identifier	
DET - 1	XX.X
DET - 2	XX.X
DET - 3	XX.X
DET - 4	XX.X
NON	XX.X
Probable R410a	

(Date)	

(Technician)	

Figure 15.

Bacharach Inc. Refrigerant Identifier	
DET - 1	XX.X
DET - 2	XX.X
DET - 3	XX.X
DET - 4	XX.X
NON	XX.X

(Date)	

(Technician)	

Figure 16.

5 Maintenance & Troubleshooting

5.1 Setting the Elevation

During the initial power-up, the Pur•Chek™ will indicate that the elevation has not been set. To set the elevation, press the “Help” button on the “Ready to Air Cal” screen as shown in Section 4.3, Figure 3. The screen will display several options as shown in Figure 17. Pressing the “SET” button will display the options in Figure 18.

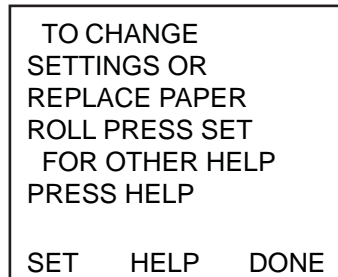

Figure 17.

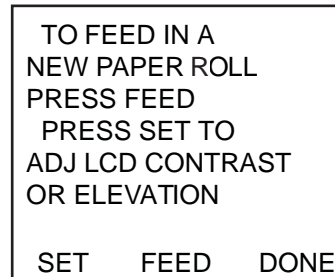

Figure 18.

Press the “SET” button shown in Figure 18 to display the screen options shown in Figure 19. Pressing the “ELEV” button will take you the elevation screen shown in Figure 20. Use the “UP” & “DOWN” buttons to adjust the unit to the elevation in your area. Press the “SAVE” button when finished to return to the help screen (Figure 17).

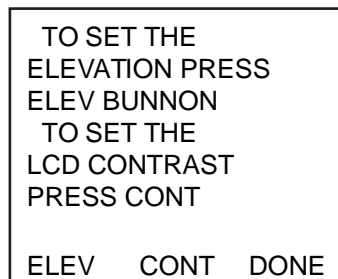

Figure 19.

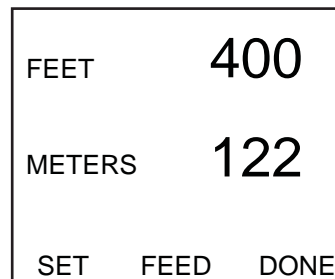

Figure 20.

5.2 Setting the LCD Contrast

The Pur•Chek™ features an adjustable LCD contrast for use in varying light conditions. To adjust the contrast, press the “HELP” button on the “Ready to Air Cal” screen as shown in Section 2.2, Figure 3. The screen will display several options as shown in Figure 17. Pressing the “SET” button will display the options in Figure 18.

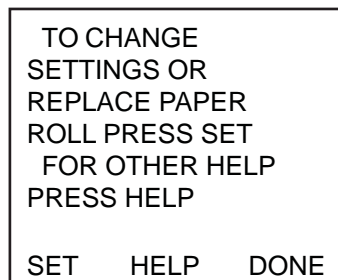

Figure 21.

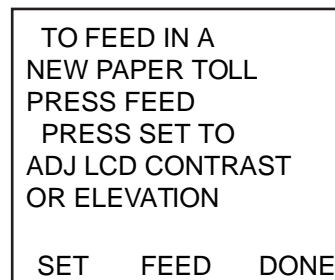

Figure 22.

Press the “SET” button shown in Figure 21 to display the screen options shown in Figure 22. Pressing the “SET” button in Figure 22 will advance the display to Figure 23. Pressing the “CONT” button will take you the contrast screen shown in Figure 24. Use the “UP” & “DOWN” buttons to adjust the screen contrast for best viewing. Press the “SAVE” button when finished to return to the help screen (Figure 21).

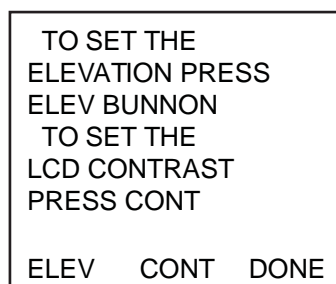

Figure 23.

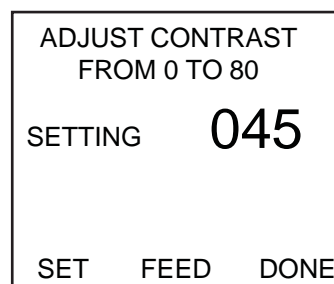

Figure 24.

5.3 Changing the Sample Filter

When inspecting the sample filter, look completely around the entire outside diameter of the white filter element located inside of the clear plastic housing. Look for red spots or the beginnings of discoloration on the white outside diameter of the element. Do not look into the round ends of the white element for red spots or discoloration. The round ends of the filter may always appear red. If red spots or discolorations are discovered, the sample filter requires replacement to prevent the influx of particulate and oil mists into the instrument.

Obtain a replacement filter, P/N 2100-0006. Remove the existing filter from the retaining clip of the instrument by pulling straight up and out. CAREFULLY remove the flexible, black rubber tubing connections from both ends of the existing filter. DO NOT allow the tubes to slip back into the internal portion of the case. Discard the existing filter in an environmentally friendly manner.

Install the tube ends onto the barbs of the replacement filter, taking note to align the flow arrow of the filter with the flow arrow of the instrument top panel. CAREFULLY slide the tubing back into the internal portion of the instrument and seat the new filter into the retaining clip. Inspect the sample hoses for signs of oil entrapment. Replacement of the sample filter usually requires cleaning or replacement of the sample hoses.

5.4 Cleaning the Sample Hoses

Inspect the inside diameter of the inner tube for signs of oil build up, dirt, obstructions, kinks, cuts, fraying, or any other signs of wear. Oil contamination can be cleaned out of sample hoses as directed below. Hoses that show signs of wear should be replaced immediately to avoid dangers of rupture or bursting.

Remove the hose from the instrument and flush with isopropyl alcohol until the oil is thoroughly cleansed from the inner tube.



WARNING: Flush hoses away from sparks, open flames or other ignition sources and in an area that is well ventilated.

Dry the hose by blowing clean, dry nitrogen or shop air through the inner hose or by allowing the hose to air-dry for several hours. Take care to not dry the hose with shop air that is lubricated. When the hose is completely dry, re-inspect the hose for signs of wear, as described above, and replace if wear is evident.

5.5 Changing the Printer Paper

Pur•Chek™ Advanced Refrigerant Identifiers that are equipped with on-board printers use a custom, inexpensive thermal paper for printing. The paper roll should be changed when a red stripe appears on the left side of the printout.

To change the paper roll, press the “HELP” button on the “Ready to Air Cal” screen as shown in Section 4.2, Figure 3. The screen will display several options as shown in Figure 25. Press the “SET” button to advance to the screen shown in Figure 26 and then press the “FEED” button.

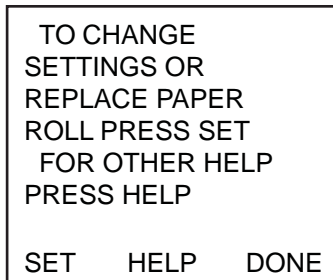

Figure 25.

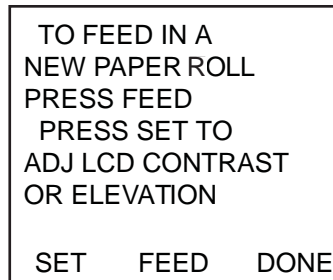

Figure 26.

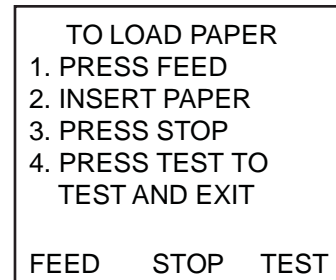
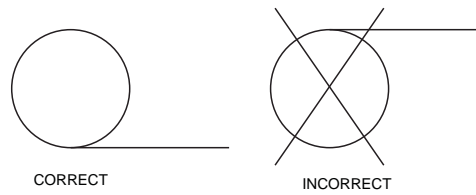

Figure 27.

Open the printer door and remove the old roll by tearing the paper as it enters the printer then pressing the "FEED" button shown in Figure 27 until the old roll exits the printer completely. Insert the new paper roll from the underside as shown below:



Press the "FEED" button shown in Figure 27 to automatically advance the paper through the printer. When the paper appears on the top of the printer, press the "STOP" button. Press the "TEST" button to print a test message and verify that the paper is installed properly. Slide the paper through the slot in the printer door and close the door.

5.6 Low Battery Warning

For units equipped with the optional rechargeable battery, a "Low Battery Warning" will appear when the battery is nearly exhausted. Several tests may be run after the initial warning however, it is strongly recommended that the unit be recharged or the external battery clips be used. Allowing the battery to fully discharge may greatly affect its service life.

5.7 Error Messages

In the unlikely event that an "Error" message is displayed on the screen, power off the unit, take it to a location outside of the shop environment where fresh air is available and turn the unit back on. If the "Error" message reappears, refer to the help screens on the instrument or contact our service department for assistance.

6 Replacement Parts

Part Number	Description
2100-0003	Printer Paper (Single Roll)
2100-0004	AC Adapter
2100-0005	Hose Assembly
2100-0006	Replacement Sample Filter
2100-0007	Optional Rechargeable Battery Kit w/ Battery and Charger
2100-0012	Spare Rechargeable Battery
2100-9000	Instruction Manual

7 Service Centers

Service and replacement parts can be found by contacting any of the following Bacharach Service Centers:

United States

Bacharach, Inc.
621 Hunt Valley Circle
New Kensington, PA 15068
Phone: 724-334-5000; press 2 at prompt
Fax: 724-334-5723
Email: help@mybacharach.com

Canada

Bacharach of Canada, Inc.
20 Amber St. Unit #7
Markham, Ontario L3R SP4
Canada
Phone: 905-470-8985
Fax: 905-470-8963
Email: bachcan@idirect.com

NOTES:

NOTES:



World Headquarters:

621 Hunt Valley Circle, New Kensington, PA 15068
PH: 724-334-5000 • Toll Free: 800-736-4666 • Fax: 724-334-5001
Website: www.mybacharach.com • Email: help@mybacharach.com

