



Portable Combustion Analyzer (PCA)

INSTRUCTION 24-9351

Operation & Maintenance

Rev. 11 – May 2004

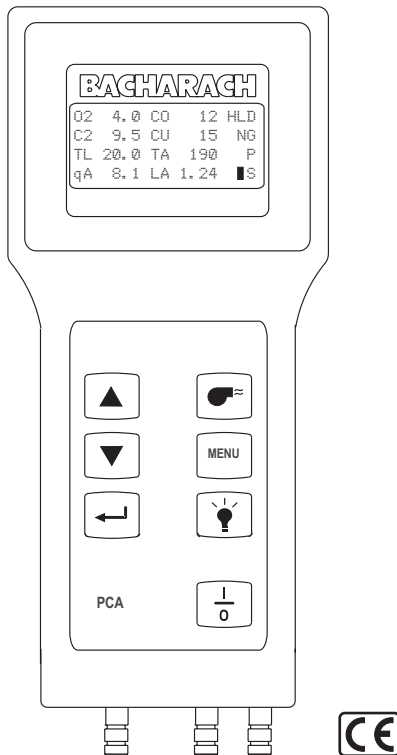

WARRANTY

Bacharach, Inc. warrants to Buyer that at the time of delivery this Product will be free from defects in material and manufacture and will conform substantially to Bacharach Inc.'s applicable specifications. Bacharach's liability and Buyer's remedy under this warranty are limited to the repair or replacement, at Bacharach's option, of this Product or parts thereof returned to Seller at the factory of manufacture and shown to Bacharach Inc.'s reasonable satisfaction to have been defective; provided that written notice of the defect shall have been given by Buyer to Bacharach Inc. within one (1) year after the date of delivery of this Product by Bacharach, Inc.

Bacharach, Inc. warrants to Buyer that it will convey good title to this Product. Bacharach's liability and Buyer's remedy under this warranty of title are limited to the removal of any title defects or, at the election of Bacharach, to the replacement of this Product or parts thereof that are defective in title.

THE FOREGOING WARRANTIES ARE EXCLUSIVE AND ARE GIVEN AND ACCEPTED IN LIEU OF (I) ANY AND ALL OTHER WARRANTIES, EXPRESS OR IMPLIED, INCLUDING WITHOUT LIMITATION THE IMPLIED WARRANTIES OF MERCHANTABILITY AND FITNESS FOR A PARTICULAR PURPOSE; AND (II) ANY OBLIGATION, LIABILITY, RIGHT, CLAIM OR REMEDY IN CONTRACT OR TORT, WHETHER OR NOT ARISING FROM BACHARACH'S NEGLIGENCE, ACTUAL OR IMPLIED. The remedies of the Buyer shall be limited to those provided herein to the exclusion of any and all other remedies including, without limitation incidental or consequential damages. No agreement varying or extending the foregoing warranties, remedies or this limitation will be binding upon Bacharach, Inc. unless in writing, signed by a duly authorized officer of Bacharach.

**Register Your Warranty by Visiting
www.bacharach-inc.com**

Notice:

Product improvements and enhancements are continuous, therefore the specifications and information contained in this document may change without notice.

Bacharach, Inc. shall not be liable for errors contained herein or for incidental or consequential damages in connection with the furnishing, performance, or use of this material.

No part of this document may be photocopied, reproduced, or translated to another language without the prior written consent of Bacharach, Inc.

Copyright © 1999–2004, Bacharach, Inc., all rights reserved.

BACHARACH is a registered trademark of Bacharach, Inc. All other trademarks, trade names, service marks and logos referenced herein belong to their respective companies.

Contents

1.0 INTRODUCTION	1-1
1.1 The Portable Combustion Analyzer	1-1
1.2 Displayed Data	1-2
1.3 Sensor Configurations	1-3
2.0 TECHNICAL CHARACTERISTICS	2-1
3.0 SETTING UP THE PCA.....	3-1
3.1 Scope	3-1
3.2 Power	3-1
3.2.1 Checking and Replacing the Batteries	3-1
3.2.2 Using the Optional Power Supply	3-2
3.3 Connecting the Probe	3-2
3.4 Configuring the PCA	3-4
4.0 OPERATION.....	4-1
4.1 Key Pad Functions	4-1
4.2 Sampling Hole Location	4-2
4.3 Combustion Test	4-3
4.3.1 Analyzer Turn On and Warm Up	4-3
4.3.2 Installing Probe in the Stack	4-4
4.3.3 Performing a Combustion Test	4-5
4.3.4 Ending a Combustion Test	4-5
4.3.5 Turning Off the Analyzer and Purging the CO Sensor	4-6
4.4 Differential Pressure Measurement	4-7
4.5 Warm-up Screen	4-8
4.6 Sensor Status Screen	4-9
4.7 Combustion Test Screen	4-10
4.8 Fuel Selection Screen	4-11
4.9 Draft Screens	4-12
4.10 Memory Directory Screen	4-13
4.11 Memory to PC Screen	4-14
4.12 ID Setup Screens	4-17
4.13 Temperature Setup Screen	4-19
4.14 Draft Unit Setup Screen	4-20
4.15 Language Setup Screen	4-21
4.16 Display Mode Setup Screen	4-22
4.17 Time/Date Setup Screen	4-23
4.18 Printer Setup Screen	4-24
4.19 Maintenance Password Screen	4-25
4.20 Maintenance Screen	4-26
4.21 User Name Screens	4-27

4.22	Saving Test Data	4-28
4.23	Printing Test Data	4-29
4.24	Clear Memory Screen	4-31
4.25	Resetting the Microprocessor	4-31
5.0	CALIBRATION.....	5-1
5.1	Sensor Check	5-1
5.2	Calibration Fixtures	5-2
5.3	Calibrate Menu Screen	5-3
5.4	Calibrate TA-Zero	5-4
5.5	Calibrate TA-Span	5-5
5.6	Calibrate TL-Zero	5-6
5.7	Calibrate TL-Span	5-7
5.8	Calibrate NX	5-8
5.9	Calibrate CO	5-9
5.10	Calibrate Draft.....	5-11
6.0	MAINTENANCE.....	6-1
6.1	Routine Maintenance	6-1
6.2	Disassembly	6-2
6.3	Cleaning the Probe	6-4
6.4	Water Trap/Filter Assembly Maintenance	6-5
6.5	Replacing the Particulate Filter	6-6
6.6	Replacing the Oxygen Sensor	6-7
6.7	Replacing the Nitric Oxide Sensor	6-8
6.7.1	Replacing the Nitric Oxide Sensor Filter	6-8
6.7.2	Replacing the Nitric Oxide Sensor Bias Battery	6-9
6.8	Replacing the Carbon Monoxide Sensor	6-10
6.8.1	Replacing the Carbon Monoxide Sensor Filter	6-11
6.9	Replacing the Pump Assembly	6-12
7.0	TROUBLESHOOTING	7-1
7.1	Analyzer Repair	7-1
7.2	Error Codes	7-2
7.3	Troubleshooting Guide	7-3
8.0	PARTS & SERVICE.....	8-1
8.1	Replacement Parts.....	8-1
8.2	Accessories	8-2
8.3	Sales/Service Centers	8-6
APPENDIX A – Display Screen Translations.....		A-1
APPENDIX B – Printout Translations		B-1

1.0 INTRODUCTION

1.1 The Portable Combustion Analyzer

The Portable Combustion Analyzer (PCA) (Figure 1-1) is a commercial grade, hand held, combustion efficiency analyzer that is designed for *continuous* (on demand) sampling of light industrial and residential furnaces, appliances, and boilers. The basic instrument is supplied with a probe, instruction manual, batteries, and carrying case.

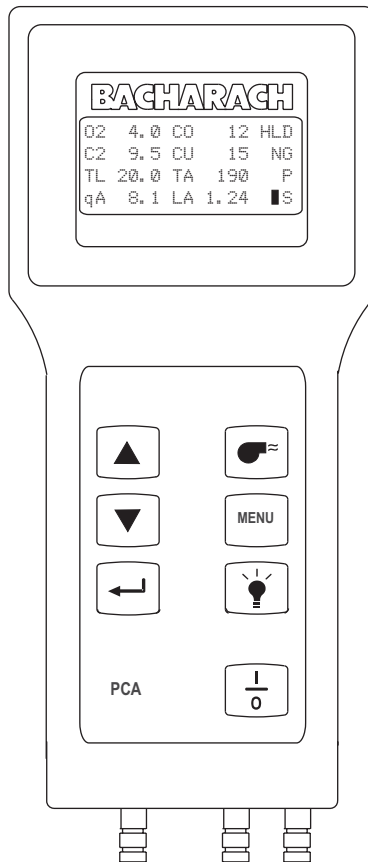

Figure 1-1. PCA

1.2 Displayed Data

The PCA directly measures, displays, and stores the following data:

- Room Temperature in °C or °F (Primary Air/Ambient Temperature)
- Flue Gas Oxygen Content in %
- Flue Gas Temperature in °C or °F
- Flue Gas Carbon Monoxide Content (H₂ Compensated) in ppm
(For analyzers having a Carbon Monoxide sensor)
- Flue Gas Nitric Oxide content in ppm
(For analyzers having a Nitric Oxide sensor)
- Pressure/Draft in Millibars, Pascals, or Inches of Water Column
(For analyzers having a draft sensor)
- Differential Pressure in Millibars, Pascals, or Inches of Water Column
(For analyzers having a draft sensor)

The PCA will compute, display, and store the following data for any of the standard fuels:

- Stack Loss in %
- Lambda
- Flue Gas Carbon Dioxide Content in %
- Flue Gas Carbon Monoxide Content referenced to 0% Oxygen in ppm
(For analyzers having a Carbon Monoxide sensor)
- Flue Gas Nitric Oxide Content referenced to 0% Oxygen in ppm
(For analyzers having a Nitric Oxide sensor)

The standard fuels are:

- Natural Gas
- Oil #2
- Oil #6
- LPG
- Koks
- Low Energy Gas
- P-Coal (available in English, German, Dutch, French, Italian, Polish, and Spanish languages)
- Biofuel (available in Danish, Finnish, and Swedish languages)

The PCA continuously monitors flue-gas-exhaust conditions and updates the above displayed values during a combustion test. If the analyzer is equipped with an optional pressure sensor, draft measurements can be made simultaneously with the combustion test, or made separately.

The analyzer has the ability to store data that was collected during a combustion test or draft measurement. The stored data can then either be viewed on the PCA's display, printed using an optional printer, or downloaded to a computer.

1.3 Sensor Configurations

TABLE 1-1. PCA SENSOR CONFIGURATIONS

PCA Models						Sensors Installed			
Standard			Advanced			Stack Temp., Air Temp. & O ₂	CO	NX	Draft (ΔP)
PCA Model	Part No.* 24-	Part No.** 24-	PCA Model	Part No.* 24-	Part No.** 24-				
10	7181	7281	40	7241	7251	X			
15	7182	7282	45	7242	7252	X			X
20	7183	7283	50	7243	7253	X	X		
25	7184	7284	55	7244	7254	X	X		X
30	7185	7285	60	7245	7255	X	X	X	
35	7186	7286	65	7246	7256	X	X	X	X

* English, Danish, Dutch, German, Finnish & Swedish languages

** English, French, German, Italian, Polish & Spanish languages

PCA 10 & 40

These basic instruments have the capability of measuring, displaying, and storing combustion tests. They will also display flue gas Oxygen content, flue gas Carbon Dioxide (CO₂) content, air temperature, flue gas temperature, stack loss, Lambda, and the current fuel selected. The 'standard' PCA 10 stores up to 10 combustion tests, while the 'advanced' PCA 40 can store up to 100 tests.

PCA 15 & 45 with Draft

In addition to the features of the basic PCAs described above, these instruments have the added capability of measuring, displaying, and saving draft or differential pressure in either Millibars, Pascals, or Inches-of-Water Column.

PCA 20 & 50 with Carbon Monoxide Measurement

In addition to the features of the basic PCAs described above, these instruments have the added capability of measuring, displaying, and saving Carbon Monoxide (CO) content, as well as calculating CO referenced to 0% Oxygen.

PCA 25 & 55 with Draft and CO Measurement

These instruments combine the features of all the PCAs listed above.

PCA 30 & 60 with CO and Nitric Oxide Measurement

In addition to the features of the basic PCAs with CO measurement, these instruments have the added capability of measuring, displaying, and saving Nitric Oxide (NX) content, as well as calculating NX referenced to 0% Oxygen.

PCA 35 & 65 with Draft, CO & NX

These instruments are capable of measuring, displaying, and saving all measurements as previously described.

Printout Capability

All PCAs have the ability to print the latest test data, or any of the saved tests, to an optional printer using HP, IrDA or RS-232 protocol.

Advanced PCA Model Features

'Advanced' models of the PCA contain the following features that are in addition to the features of their corresponding 'standard' PCAs:

- 100 memory locations
- RS232 output for transferring saved data to a Personal Computer
- Ability to enter three lines of user-identification information that is printed at the top of each printout
- Ability to enter three lines of customer-identification information that is printed with each test record.
- Automatic CO sensor purge on analyzers equipped with a CO sensor

2.0 TECHNICAL CHARACTERISTICS

The PCA Directly Measures and Displays:

- Oxygen content in flue gas in the range of 0.1 to 20.9 % O₂
- Flue gas temperature in the range of -18 to 1200 °C (0 to 2192 °F)
- Primary-air / ambient temperature is in the range of -18 to 999 °C (0 to 999 °F)

Optional . . .

- Differential pressure/draft in the range of ±70.0 mb (±28" H₂O)
- Carbon Monoxide* content in flue gas in the range of 0 to 4000 ppm
- Nitric Oxide* content in flue gas in the range of 0 to 1000 ppm

The PCA Computes and Displays:

(When the measured oxygen level is not above 18.8%, and the Stack (Flue Gas) temperature is not above 1200 °C (2192 °F)

- Stack loss in the range of 0.1 to 99.9%
- Carbon Dioxide content in flue gas from 0.1 to a fuel dependent maximum value in percent
- Lambda in the range of 1 to 9.95
- Carbon Monoxide* content referenced to 0% Oxygen in the range of 0 to 9,999 ppm on analyzers equipped with a CO sensor.
- Nitric Oxide* content referenced to 0% Oxygen in the range of 0 to 9,999 ppm on analyzers equipped with a NX sensor.

Standard Fuels** Available for Combustion Calculations:

- Natural Gas
- Koks
- LEG
- LPG
- Oil #2
- Oil #6
- P-Coal (available in English, German, Dutch, French, Italian, Polish, and Spanish languages)
- Biofuel (available in Danish, Finnish, and Swedish languages)

* For the PCA 30, 35, 60, & 65, the display can be set up to show either measured values of Carbon Monoxide and Nitric Oxide (CO & NX), or show the calculated values of these gases (CU & NU) referenced to 0% Oxygen. In either case, all values are listed on the printout of analyzers equipped with a printer.

** Custom fuels available upon request. Contact factory for details.

Normal Operating Conditions:

Temperature:

Analyzer 0 to 40 °C (32 to 104 °F)
 Probe 800 °C (1472 °F) Max.

Humidity:

Analyzer 15 to 90% Relative Humidity, Non-Condensing

Air Pressure:

Analyzer Atmospheric
 Probe 25 mb (10" H₂O) draft max at probe tip

Performance:

Accuracy:

Oxygen* ±0.3% O₂
 Carbon Monoxide ±5% of reading or ±10 ppm, whichever is greater
 between 0 – 2000 ppm, and ±10% of reading
 between 2001 – 4000 ppm.

Nitric Oxide ±5% of reading or ±5 ppm, whichever is greater

Flue Gas Temp. ±2 °C between 0 and 124 °C
 (±4 °F between 32 and 255 °F)
 ±3 °C between 125 and 249° C
 (±6 °F between 256 and 480 °F)
 ±4 °C between 250 and 400 °C
 (±8 °F between 481 and 752 °F)

Ambient Temp. ±1 °C between 0 and 100° C
 (±2 °F between 32 and 212 °F)

Pressure ±2% of reading or ±0.05 mb (±0.02 inches of
 Water Column), whichever is greater

System Flow Rate:

With probe 200 cc/min minimum

Front Panel Controls:

Seven embossed push-button switches with tactile feedback (refer to Section 4.1)

* Accuracy referenced in practical flue gas concentrations
 (mixtures of O₂, CO₂ and N₂)

Display:

20 character by 4 line alphanumeric LCD panel with a green backlight.

Power Requirements:

Four disposable AA alkaline batteries. Battery backup for the real-time clock, RAM, and bias voltage for the Nitric Oxide sensor are provided by internal lithium batteries. Optional AC Power Supplies (110 VAC & 230 VAC) are also available.

Operating Time:

A fresh set of four disposable AA alkaline batteries provides at least 8 hours of continuous operation with the pump running and the backlight turned on.

Warm Up Time:

60 seconds.

Printer Interface:

Infrared & RS-232 Communications (refer to Section 4.23).

Materials:

- High impact ABS plastic case
- Polycarbonate window over the display
- Nickel plated, brass quick-connect hose fitting
- Stainless steel probe

Dimensions:

Height: 215 mm (8.5 in.)
Width: 96 mm (3.8 in.) at display (75 mm [3.0 in.] at controls)
Depth: 50 mm (2 in.)

Weight:

With Batteries: Approximately 0.7 Kg (1.5 lbs)

Agency Approvals:

- TÜV Agency Approved (1.BImSchV - First Ordinance of the German Federal Emissions Law)
Approval Number: TÜV By RgG 168

- CE declaration of conformity

Manufacturer's name: Bacharach, Inc.
 Manufacturer's address: 621 Hunt Valley Circle
 New Kensington, PA 15068

European operations: Bacharach Instruments
 Sovereign House, Queensway
 Royal Leamington Spa
 Warwickshire CV31 3JR
 United Kingdom

Product name: Portable Combustion Analyzer (PCA)
 conforms to the following CE requirements:
 EN 50081-1, January 1992 (Emissions)
 EN 50082-1, January 1992 (Immunity)

Equations

$$C2 = CO_{2max} \times \left(\frac{21 - O_2}{21} \right)$$

$$qA = (TA - TL) \times \left(\frac{A2}{(21 - O_2)} + B \right)$$

$$LA = \frac{21}{21 - O_2}$$

$$CU = CO \times \left(\frac{21}{21 - O_2} \right)$$

$$NU = NO \times \left(\frac{21}{21 - O_2} \right)$$

Where:

- O₂ = Measured Oxygen in percent
- TA = Measured stack temperature in °C
- TL = Measured primary air temperature in °C
- CO = Measured Carbon Monoxide in ppm
- NO = Measured Nitric Oxide in ppm
- C2 = Calculated Carbon Dioxide in percent
- qA = Calculated stack loss in percent
- LA = Calculated Lambda
- CU = Calculated Carbon Monoxide referenced to 0% Oxygen
- NU = Calculated Nitric Oxide referenced to 0% Oxygen

CO_{2max}, A2, and B are constants (see below)*:

Fuel	CO _{2max}	A2	B
NG	11.8	0.66	0.009
KOKS	10.2	0.60	0.011
LEG	13.1	0.63	0.011
LPG	13.8	0.63	0.008
Oil#2	15.4	0.68	0.007
Oil#6	15.9	0.68	0.007
P-Coal	18.7	0.60	0.007
Biofuel	20.4	0.70	0.012

* Some constants vary for Danish, Italian, and Polish fuels

3.0 SETTING UP THE PCA

3.1 Scope

Before using the PCA, you **MUST**:

- Check the batteries or plug in an optional Power Supply (Section 3.2)
- Connect the probe to the analyzer (Section 3.3)
- Check the analyzer's configuration (Section 3.4)

3.2 Power

3.2.1 *Checking and Replacing the Batteries*

A fresh set of batteries is supplied with the PCA. Install the batteries as described below. Check for a sufficient charge prior to each use. If a **LOW BATTERY** message is displayed, replace the batteries.

1. Remove the battery cover from the back of the PCA (Figure 3-1).
2. Remove (and properly dispose of) the old batteries.
3. Install a new set of four AA alkaline batteries, making sure to properly orient them as indicated by the "+" and "-" terminals in the battery compartment.
4. Replace the battery cover.

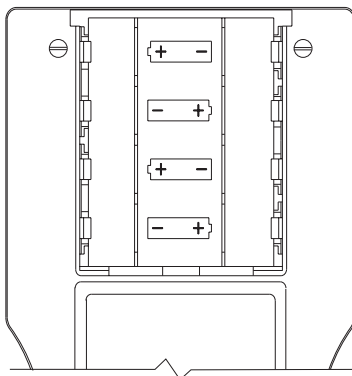

Figure 3-1. Battery Replacement

3.2.2 Using the Optional Power Supply

If an Optional Power Supply is to be used:

1. Connect the output plug of the Optional Power Supply to the analyzer's power supply jack (Figure 3-2).
2. Plug the Optional Power Supply into an appropriate AC wall outlet. The analyzer will now operate and function normally.

3.3 Connecting the Probe

To attach the probe to the analyzer (Figure 3-2):

1. Push the yellow-banded, quick-connect Flue Gas Hose (giving a slight twist) onto the analyzer's GAS sample-inlet fitting.
2. Push the blue-banded, quick-connect Draft Hose (giving a slight twist) onto the analyzer's DRAFT sample-inlet fitting.
3. Push the Flue Gas Thermocouple into the T-STACK jack (connector fits in only one way).

NOTE: *The PCA has a built in room-air thermocouple. Perform Step 4 only if the Optional Room Air/Primary Air Thermocouple is used.*

4. Push the Optional Room Air/Primary Air Thermocouple into the T-AIR jack (connector fits in only one way).

NOTE: *In order for the PCA to correctly calculate combustion efficiency when the burner's primary-air temperature is not the same as room temperature, the primary-air temperature should be measured using the optional Primary Air Thermocouple.*

Inspect all the hoses for cracks. If any hose is defective, replace the entire probe assembly. Check that the water trap is dry and the filter is not dirty or saturated with water.

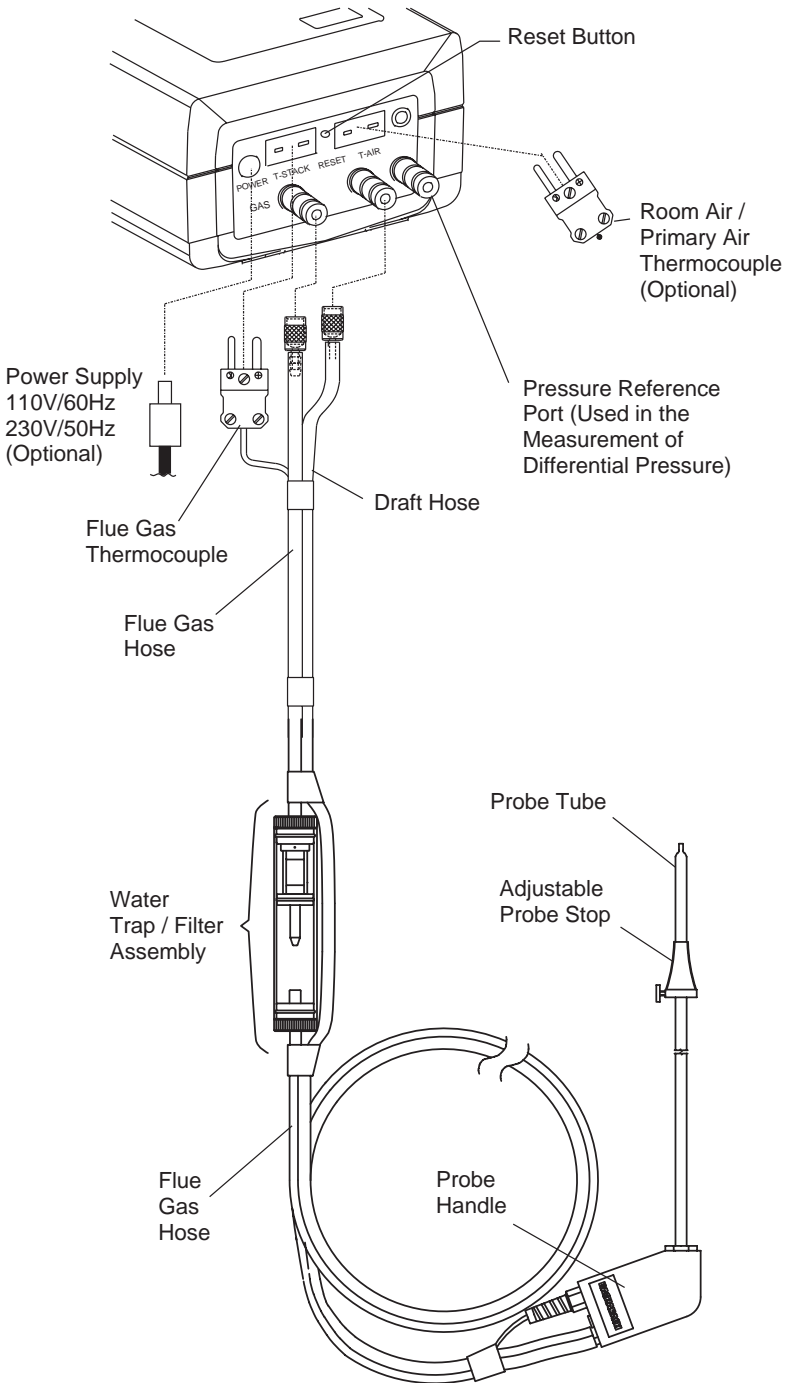

Figure 3-2. Connecting the Probe to the Analyzer

3.4 Configuring the PCA

The PCA is configured at the factory for the parameters shown below, but can be changed by following the instructions in the associated sections.

Function	Parameters	To Change, Refer to . . .
Fuel	Natural Gas	Section 4.8
Temperature	°C	Section 4.13
Optional Draft	MB	Section 4.14
Language	English	Section 4.15
Display Mode*	CO & NX	Section 4.16
Time	HR:MIN:SEC	Section 4.17
Date**	DD.MM.YY	Section 4.17
Printer	IrDA	Section 4.18

* Available only on the PCA 30, 35, 60, & 65

** The year displays as two digits on the instrument, and four digits on the printout.

4.0 OPERATION

4.1 Key Pad Functions

Descriptions of the key pad functions are given below. Note that most of the front panel key pad buttons perform multiple functions as determined by what screen is being displayed at the time.



Turns the analyzer ON and OFF. Note that there is a 5 second delay before the instrument actually turns OFF, thus allowing an operator to turn the instrument back ON by pressing the  key to prevent the accidental loss of test data.



Moves the cursor [z] in front of a menu item up through the displayed items. This key also increases alphanumeric values in screens requiring a value change.







Moves the cursor [z] in front of a menu item down through the displayed items. This key also decreases alphanumeric values in screens requiring a value change.



Chooses the highlighted item (the item with the cursor [z] in front of it) in all menus and screens. This key also causes the cursor to enter the number field in the Maintenance Password Screen, and causes the cursor to advance to the next field position in screens requiring multiple alphanumeric entries.



Starts and stops a combustion test when the Combustion Test Screen is displayed. Pressing this key in any other screen almost always returns the instrument to the Combustion Test Screen. However, there are four situations where this key behaves as an enter key: 1) After entering a correct password in the Password Screen, press the  key to display the first calibration screen. 2) After entering an offset or span value in any of the Calibration Edit Screens, press the  key to store the new values. 3) After entering a time or date value in the Time/Date Setup Screen, press the  key to store the new values and return the cursor to the left side of the display. 4) After entering text in either the ID Setup or User Name Screens, press the  key to store the text.



Advances the display to the next menu screen.



Turns the backlight ON and OFF.

4.2 Sampling Hole Location

The analyzer requires that a 13 mm (½ in.) diameter sampling hole be made in the furnace stack to accommodate the probe stop on the Probe and Hose Assembly.

Locate the sampling hole downstream from the last heat exchanger, and upstream from any source of dilution, such as a draft diverter (Figure 4-1).

IMPORTANT! *As the distance between the last heat exchanger and sampling point increases, stack loss will falsely decrease due to heat loss by convection from the flue or stack.*

For residential and light-commercial combustion-equipment applications, the following recommendations are applicable:

- **Oil Gun Burners** – Locate sampling hole at least 30 cm (12 in.) downstream from the furnace breaching, and at least 15 cm (6 in.) upstream from the furnace side of the draft regulator.
- **Gas Burners** – Locate sampling hole at least 15 cm (6 in.) upstream from the furnace side of the draft diverter on gas-converted units. For gas-designed equipment, the probe may be inserted down into the flue through the draft diverter or hood.

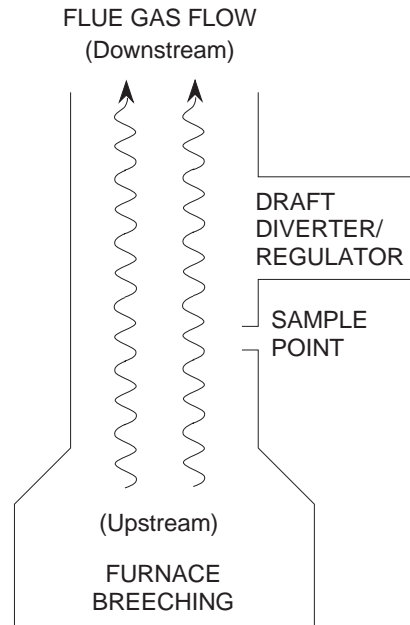

Figure 4-1. Sampling Hole Location

4.3 Combustion Test

IMPORTANT! *Large rapid changes in the temperature of the analyzer can affect its accuracy. This is important to know if the analyzer is stored in a cold place (such as an unheated vehicle in the winter) and then taken into a warm furnace area. For the most accurate test results, allow the analyzer to warm up to room temperature before use (about 10 minutes).*

4.3.1 Analyzer Turn On and Warm Up

IMPORTANT! *Be sure the probe is at room temperature before performing the following steps.*

1. Make sure that the analyzer is properly set up per Section 3.0.
2. Place probe in an area of fresh, ambient air; then press the analyzer's $\frac{1}{\circ}$ key.
3. Wait for the analyzer to countdown through its 60 second warmup period; then perform one of the following:
 - **If no errors were detected during warmup**, the Combustion Test Screen will be displayed. Skip Step 4, and go to Section 4.3.2.
 - **If an error was detected during warmup**, proceed with Step 4.
4. If one or more errors were detected by the microprocessor during warmup, these errors will be displayed at the bottom of the Sensor Status Screen. Address any problems now per Section 7.2; then repeat this procedure starting with Step 1.

NOTE: *If the error detected is not critical to your test, the instrument can still perform any test not using the function disabled by the error.*

4.3.2 Installing Probe in the Stack

1. After making a sampling hole in the stack (Section 4.2), and turning on the analyzer (Section 4.3.1), screw the probe stop supplied with the Probe and Hose Assembly into the sampling hole (Figure 4-2).
2. Insert the probe through the hole in the probe stop, then position the probe tip inside the stack, near its center. Tighten the thumbscrew on the probe stop to secure the probe.

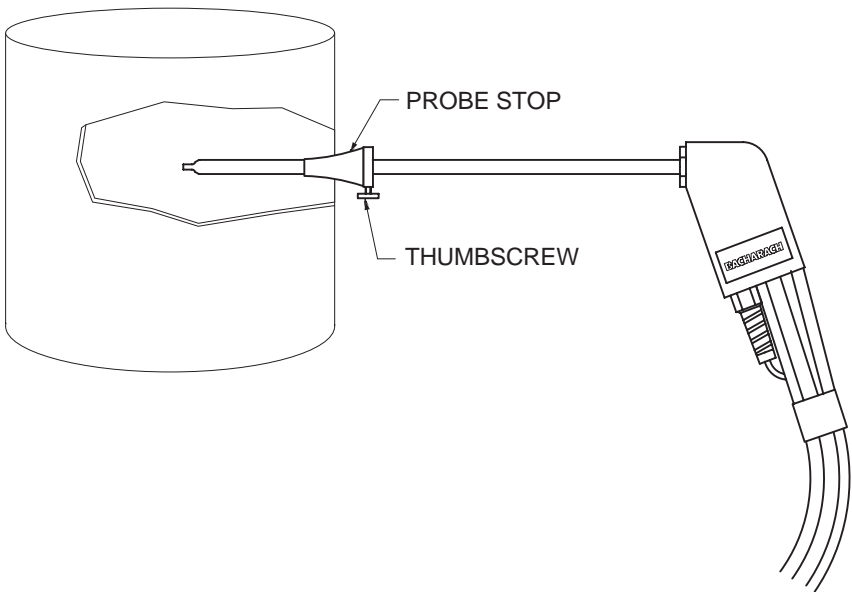

Figure 4-2. Installing the Probe

4.3.3 Performing a Combustion Test

IMPORTANT: *If the burner's primary-air temperature is not the same as the room temperature, then be sure the Optional Room Air / Primary Air Thermocouple is installed per Section 3.3.*

1. With the Combustion Test Screen displayed and the probe installed in the stack, press the **☐** key to start a combustion test (refer to Section 4.7).
2. Once all sensor readings are indicated on the screen: A) Loosen the thumbscrew on the probe stop. B) Move the probe in and out of the stack until the stack's core temperature (hot spot) is located. C) Tighten the thumbscrew to prevent further movement of the probe. *Locating the highest stack temperature is very important for accurate combustion calculations.*
3. You can now begin burner-service procedures. The readings on the analyzer change quickly to show changes in burner performance.

CAUTION

With the Water Trap / Filter Assembly stood up on its Outlet End, do not let water condensate build up beyond the tip of the riser tube. The sensors could be damaged if water would enter the analyzer. Drain the water condensate after every combustion test (refer to Section 6.4).

4. Pressing the **←** key will *save* the Combustion Test Screen readings while a test is in progress. Moving the cursor (z) in front of the print (**☐**) function using the **s** key, and then pressing **←** will print the test information to an optional printer.

4.3.4 Ending a Combustion Test

1. Press the **☐** key to end a combustion test.

WARNING!

Burn hazard! Allow a hot probe to cool for about 5 minutes before handling.

CAUTION:

*Do not place a hot probe inside the instrument's carrying case.
Allow the probe to cool before storage.*

2. Loosen the thumbscrew on the probe stop; then remove the probe and probe stop from the stack.
3. If data was saved during the combustion test, you can turn off the analyzer and review or print the stored data at a later time as described in Sections 4.10 and 4.23.

4.3.5 Turning Off the Analyzer and Purging the CO Sensor

Turn off the analyzer by pressing the $\frac{1}{0}$ key.

If the $\frac{1}{0}$ key is pressed while the CO reading is 100 ppm or higher, the pump will automatically turn on (if not already running) to purge the analyzer of CO.

IMPORTANT! *The analyzer's probe must be removed from the stack during the purging process to allow fresh air to be drawn through the analyzer.*

The following message is displayed while the analyzer is being purged.



PURGING CO SENSOR

As soon as the CO level falls below 100 ppm, the pump turns off and the analyzer starts its normal 5 second turn-off sequence.

To abort the purging process and immediately start the analyzer's turn-off sequence, press the $\frac{1}{0}$ key.

NOTE: *Turning the analyzer off initiates a 5-second delay, during which time the unit can be turned on again without any warmup time. You can turn the analyzer back on during this 5-second delay by pressing the $\bullet^{\text{=}}$ key.*

4.4 Differential Pressure Measurement

The difference in pressure (ΔP) between two areas can be measured by using the PCA's two pressure ports and DRAFT Screen. By using Pressure Port 2 (-) as the reference, the pressure applied to Port 1 (+) will be displayed on the DRAFT Screen as the differential pressure between the two ports.

1. Turn on the analyzer by pressing the $\frac{1}{0}$ key; wait for the warmup cycle to complete; then press the **MENU** key until the first DRAFT Screen is displayed (refer to Section 4.9). *If a TA-SENSOR ERROR is displayed because the probe's thermocouple is not plugged into the analyzer, then press the $\bullet^{\text{=}}$ key to acknowledge the error before pressing the **MENU** key.*
2. While the first DRAFT Screen is displayed, remove any hoses connected to Pressure Ports 1 and 2; then press the \leftarrow key to zero these ports at atmospheric pressure.

3. Connect two sampling hoses to Pressure Ports 1 and 2 (Figure 4-3). Then place the open end of each hose into the areas being measured.

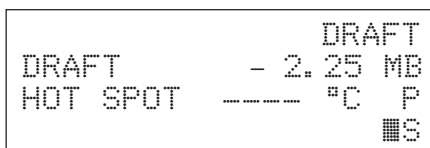

DRAFT
DRAFT - 2.25 MB
HOT SPOT ----- °C P
■S

4. The differential pressure between the two areas is now displayed on the third DRAFT Screen. If the pressure at Port 1 is higher than Port 2, then the pressure difference will be *positive*. But if the pressure at Port #1 is lower, then the pressure difference will be *negative*. The reading shown in this example indicates that the pressure at Port 1 is 2.25 mb *lower* than the pressure at Port 2.

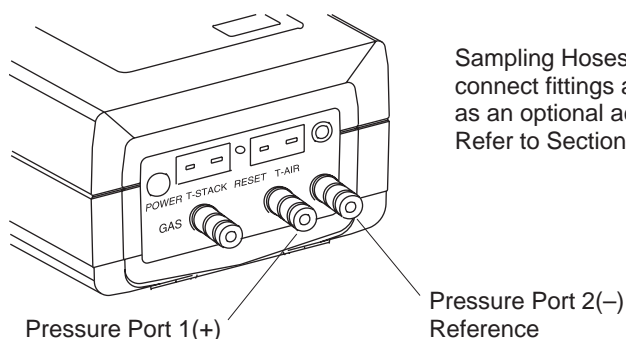

Sampling Hoses with quick-connect fittings are available as an optional accessory. Refer to Section 8.2.

Figure 4-3. Differential Pressure Hose Connections

4.5 Warmup Screen

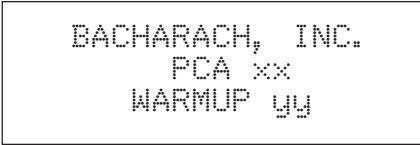

```

BACHARACH, INC.
  PCA xx
WARMUP yy
  
```







Where: xx = Instrument Model Number
yy = Counts down from 60 seconds

As soon as the $\frac{1}{0}$ key is pressed, the instrument's serial number and software version number are displayed for approximately 3 seconds. To continuously display these items, hold down the $\frac{1}{0}$ key at start-up. The warmup cycle continues after the $\frac{1}{0}$ key is released.

The Warmup Screen is displayed during the analyzer's 60 second warmup cycle, during which time the "Warmup" value (yy) counts down to zero.

After the warmup cycle is complete (and if the unit is working correctly) the instrument will flash `NO ERRORS DETECTED` and go directly to the Combustion Test Screen (Section 4.7). If there is a problem, however, with one or more of the sensors, the Sensor Status Screen (Section 4.6) is displayed with error message(s) appearing at the bottom of the screen.

Front Panel Key Functions:

-  – No Action
-  – No Action
-  – No Action
-  – No Action
-  – No Action
-  – Toggle Backlight ON/OFF*
-  – Turn analyzer OFF*

* The  button will always turn the backlight on and off, and the $\frac{1}{0}$ key will always turn the analyzer on and off. These two keys will not be mentioned in the remainder of this section.

4.6 Sensor Status Screen

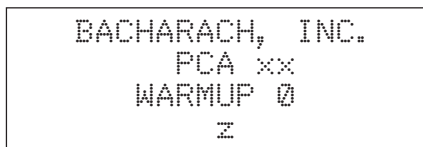

Where: xx = Instrument Model Number
z = Sensor(s) in error

If there is problem with one or more of the sensors, the Sensor Status Screen will be displayed after the analyzer has gone through its warmup cycle (refer to Section 7.2 for a listing of the error codes).

Front Panel Key Functions:



- No Action



- No Action



- No Action



- Go to Combustion Test Screen



- No Action

4.7 Combustion Test Screen

PCA models 10–25, 40–55

O2	4.0	CO	12	HLD
C2	9.5	CU	15	NG
TL	20.0	TA	190	P
qA	8.1	LA	1.24	■S

PCA models 30, 35, 60, & 65

O2	4.0	CO	12	HLD
C2	9.5	NX	10	NG
TL	20.0	TA	190	P
qA	8.1	LA	1.24	■S

- OR -

O2	4.0	CU	15	HLD
C2	9.5	NU	12	NG
TL	20.0	TA	190	P
qA	8.1	LA	1.24	■S

This screen shows:

- O2 Oxygen content in flue gas (%)
- C2 Carbon Dioxide content present in flue gas (%)
- TL Primary/Ambient air temp. (°F)
- qA Stack Loss
- CO* Carbon Monoxide content in flue gas (ppm)
- CU* Carbon Monoxide content referenced to 0% Oxygen (ppm)
- TA Stack (Flue gas) temperature (°F)
- LA LAMBDA
- NX* Nitric Oxide content in flue gas (ppm)
- NU* Nitric Oxide content referenced to 0% Oxygen (ppm)
- HLD/RUN .. PCA on hold / PCA running test
- NG Fuel code for natural gas (see Section 4.8 for other codes)
- P Print Data
- S Save Data

* For PCA models 30, 35, 60 and 65, you have the option of displaying either CO & NX, or CU & NU. Refer to Section 4.16 for setup instructions.

NOTE: Refer to Section 7.3 if stars (****), dashes (----), or Xs (XXXX) appear in the display.

Front Panel Key Functions:



– Move cursor (z) up



– Move cursor (z) down



– Save or Print screen data



– Run test / Stop test



– Go to Fuel Selection Screen

4.8 Fuel Selection Screen

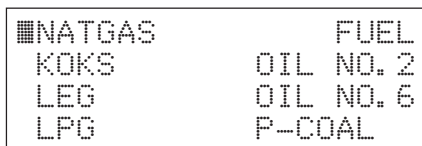

This screen is displayed by pressing the **MENU** key from the Combustion Test Screen. This screen is used to select the fuel being burned.

To select a fuel, first use the **ST** keys to move the cursor (**z**) in front of the desired fuel, and then press the **←** key.

NOTE: *The fuel selected is saved as the default, and remains in memory after the PCA is turned off.*

The fuel codes as displayed in the Combustion Test Screen:

NG = Natural Gas	O#6 = Oil No. 6
KOK = Coal Gas	PC = P-Coal (English, German, Dutch, French, Italian, Polish, and Spanish) or Biofuel (Danish, Finnish, and Swedish)
LPG = Propane	
O#2 = Oil No. 2	

Front Panel Key Functions:



– Move cursor (**z**) up



– Move cursor (**z**) down



– Select Fuel



– Go to Combustion Test Screen



– Go to Draft Screens

4.9 Draft Screens





The first Draft Screen is displayed by repeatedly pressing the **MENU** key from the Combustion Test Screen.

To measure draft, first zero the analyzer's pressure sensor to atmospheric pressure by disconnecting the draft hose from the bottom of the instrument, and then pressing the \leftarrow key. Reconnect the draft hose after the second Draft Screen appears (shown for 3 seconds). The third screen shows the current values of draft and stack temperature as measured by the analyzer.

When using the analyzer to make a differential pressure measurement (Section 4.4), the differential pressure value will be displayed on the third Draft Screen.

To save (☺) or print (☒) the screen data, first use the **st** keys to move the cursor (z) in front of the desired function, and then press the \leftarrow key.

Front Panel Key Functions:

-  – Move cursor (z) up
-  – Move cursor (z) down
-  – Save or Print screen data
-  – Go to Combustion Test Screen
-  – Go to Memory Directory Screen

```

                                     DRAFT
DISCONNECT DRAFT
HOSE
PRESS ↵
  
```

```

                                     DRAFT
RECONNECT DRAFT
HOSE
  
```

```

                                     DRAFT
DRAFT      - 0.25 XX
HOT SPOT   190 °C  P
                                     S
  
```

Where: xx = Unit of measure.
Default is millibars (MB). See
Optional Draft SETUP Screen
(Section 4.14) for other choices.

4.10 Memory Directory Screen

'Standard' PCA Screen

```

      MEMORY DIRECTORY
  ■M8 28.7.97 15:45
  M9 MEMORY EMPTY
  CLEAR MEMORY
  
```

'Advanced' PCA Screen

```

      MEMORY DIRECTORY
  ■98 28.7.97 15:45
  99 MEMORY EMPTY
  CLEAR MEMORY
  
```

The Memory Directory Screen is displayed by repeatedly pressing the **MENU** key from the Combustion Test Screen. This screen is used to select a memory location that contains saved data which an operator can re-view.





NOTE: A 'standard' PCA has 10 memory locations numbered M0 thru M9, while an 'advanced' PCA has 100 memory locations numbered 0 thru 99.

To select a data-memory location, first use the **st** keys to move the cursor (*z*) in front of the desired memory location; then press the **←** key. The saved data is now displayed in either the Combustion Test Screen or Draft Screen, depending on whether the chosen memory location contains combustion or draft information. To print the saved data, refer to Section 4.23.

After viewing or printing the saved data, use the **st** keys to move the cursor (*z*) to the exit (**⏏**) function; then press **←**. This will redisplay the memory directory.

Selecting the **CLEAR MEMORY** function displays the Clear Memory Screen from where all saved data can be erased (refer to Section 4.24).

Front Panel Key Functions:

-  – Move cursor (*z*) up
-  – Move cursor (*z*) down
-  – Display the data saved at the chosen memory location
-  – Go to Combustion Test Screen
-  – Go to Temperature Setup Screen, or the Memory To PC Screen for Advanced units

4.11 Memory to PC Screen

(For 'Advanced' PCA Models 40, 45, 50, 55, 60 & 65)

```

      MEMORY TO PC
■ TRANSMIT DATA
  CLEAR MEMORY
  
```

The Memory To PC Screen is displayed by repeatedly pressing the **MENU** key from the Combustion Test Screen. Use this screen to either transmit *all* stored memory locations to a computer, or clear *all* memory locations.

TRANSMIT DATA

Before data can be transmitted to a personal computer, the PCA's RS-232 output must first be connected to an unused COM port on the computer using serial data cable Part No. 24-1073 (see Figure 4-4). Also, a communications program (i.e., ProcommPlus®, Windows 3.x Terminal, or Windows 9x Hyper Terminal) must be installed, and its communications parameters configured for: **9600 baud, 8 data bits, 1 stop bit, no parity, and no handshaking**.

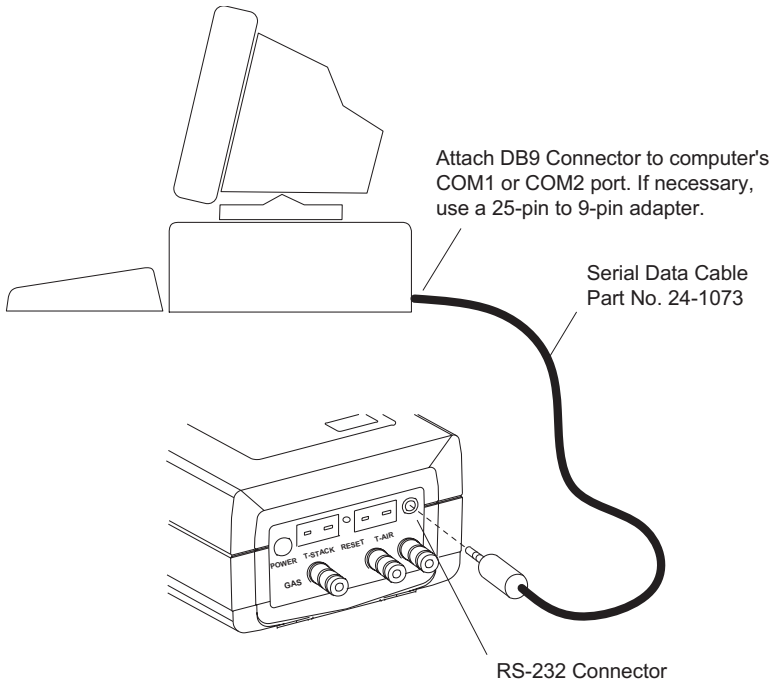

Figure 4-4. Connecting the Serial Data Cable

Data is transmitted to a computer in ASCII *comma-delimited* format, which can be captured as a text file and then opened in most commercially available spreadsheet programs. Note that each data record consists of 20 fields, some of which may be blank for different tests and PCA models as listed in Tables 4-1 & 4-2.

Use the communication software to capture and save the received data as an ASCII text file. Consult the software's documentation for detailed instructions on how to perform this procedure.

To start transmitting data, first use the `st` keys to position the cursor (`z`) in front of `TRANSMIT DATA` and then press the `↵` key. Observe that as PCA downloads its data, the word `TRANSMITTING....` appears on the display.

CLEAR MEMORY

To clear *all* memory locations, first use the `st` keys to position the cursor (`z`) in front of `CLEAR MEMORY` and then press the `↵` key. The Clear Memory Screen will then appear from where all saved data can be erased (refer to Section 4.24).

Front Panel Key Functions:



– Toggle cursor (`z`) position



– Toggle cursor (`z`) position



– Select function next to cursor



– Go to Combustion Test Screen



– Go to ID Setup Screen

TABLE 4-1. COMMA-DELIMITED FIELDS

Field	Data Name or Value	Label in Column Headings
1	Instrument serial number	SN
2	ID line 1 (up to 16 characters)	ID1
3	ID line 2 (up to 16 characters)	ID2
4	ID line 3 (up to 16 characters)	ID3
5	Time of test (hh:mm:ss)	TIME
6	Date of test (dd.mm.yyyy)	DATE
7 ¹	Name of fuel (up to 16 characters)	FUEL
8 ¹	Flue gas temperature	TA
9 ¹	Air temperature	TL
10 ¹	Temperature unit of measure (F or C)	C/F
11 ¹	O ₂ concentration in %	O2
12 ¹	CO ₂ concentration in %	C2
13 ^{1,2}	CO concentration in ppm	CO
14 ^{1,2}	CO referenced to 0% O ₂ in ppm	CU
15 ^{1,3}	NO concentration in ppm	NX
16 ^{1,3}	NO referenced to 0% O ₂ in ppm	NU
17 ¹	qA in %	qA
18 ¹	Lambda	LA
19	Draft measurement	DR
20	Draft unit of measure	MB/PA/WC

¹ Empty data field for draft tests
² Empty data field for PCA Models 40 and 45
³ Empty data field for PCA Models 40, 45, 50, and 55

TABLE 4-2. TYPICAL SPREADSHEET FOR A PCA 65

SN	ID1	ID2	ID3	TIME	DATE	FUEL	TA	TL	C/F	O2
AX1020	ID LINE 1	ID LINE 2	ID LINE 3	9:03:27	19.01.1999	NATGAS	190	20	C	4
AX1020	ID LINE 1	ID LINE 2	ID LINE 3	9:10:35	19.01.1999					

C2	CO	CU	NX	NU	qA	LA	DR	MB/PA/WC
9.5	12	15	10	12	8.1	1.24	-0.25	MB
							-0.25	MB

Line 1: Column Headings
 Line 2: Typical Combustion Readings
 Line 3: Typical Draft Reading

4.12 ID Setup Screens





(For 'Advanced' PCA Models 40, 45, 50, 55, 60 & 65)



This initial ID Setup Screen is displayed by repeatedly pressing the **MENU** key from the Combustion Test Screen. Use this screen to edit three lines of customer information (i.e., the customer's name, location, and burner reference number).

Each ID line can be up to 16 alphanumeric characters in length. All three lines will appear at the top of each test record for the purpose of identifying individual tests.

Front Panel Key Functions for the Initial ID SETUP Screen:

-  – Move cursor (z) upward
-  – Move cursor (z) downward
-  – Select ID Number that is next to the cursor for editing
-  – Go to Combustion Test Screen
-  – Go to Temperature Setup Screen

To enter a line of text, first use the **st** keys to position the cursor (z) in front of the desired ID line; then press **←**. The selected ID Line Number Screen will then appear.

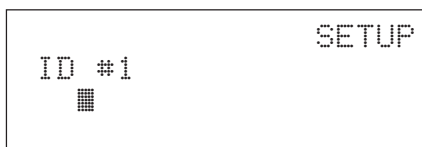

Now press the **st** keys until the desired letter or number is displayed. Available characters include:

“(space)ABCDEFGHIJKLMNPOQRSTUVWXYZ0000000123456789”

Press \leftarrow to save the selected character and advance to the next position. If you make a mistake, press \leftarrow until the cursor is over the incorrect character and make your correction by again using the st keys. After all the desired characters have been selected, press the OK key to save the text line and return to the initial ID SETUP Screen.

NOTE: *The entered ID information will be saved with all future memory records until it is modified or deleted.*

Front Panel Key Functions for the Individual ID SETUP Screens:



- Increment character



- Decrement character



- Select the displayed character and advance to the next character position



- Save the text line and return to the initial ID SETUP Screen



- Abort any changes to the text line and return to the initial ID SETUP Screen

4.13 Temperature Setup Screen

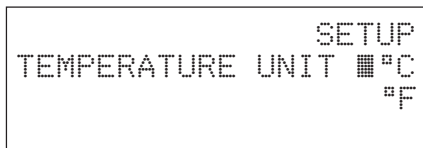

The Temperature Setup Screen is displayed by repeatedly pressing the **MENU** key from the Combustion Test Screen. Use this screen to setup the analyzer to display temperature in either °C or °F.

To select the instrument's temperature unit-of-measure, first use the **st** keys to move the cursor (z) in front of °C or °F, and then press the **←** key.

Front Panel Key Functions:



– Move cursor (z) up



– Move cursor (z) down



– Select temperature unit of measure next to cursor



– Go to Combustion Test Screen



– Go to Draft Unit Setup Screen



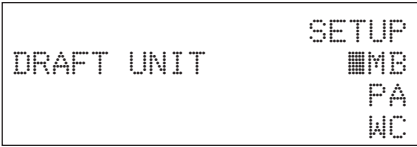

4.14 Draft Unit Setup Screen



The Draft Unit Setup Screen is displayed by repeatedly pressing the **MENU** key from the Combustion Test Screen. Use this screen to setup the analyzer to display draft in either millibars (MB), Pascals (PA), or inches-of-water column (WC).

To select the draft unit-of-measure, first use the **st** keys to move the cursor (**z**) in front of **MB**, **PA** or **WC**, and then press the **←** key.

Front Panel Key Functions:

-  – Move cursor (**z**) up
-  – Move cursor (**z**) down
-  – Select draft unit of measure
-  – Go to Combustion Test Screen
-  – Go to Language Setup Screen

4.15 Language Setup Screen

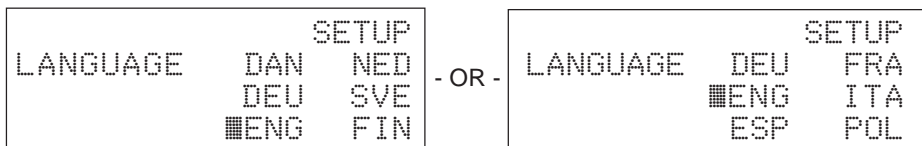

The Language Setup Screen is displayed by repeatedly pressing the **MENU** key from the Combustion Test Screen. Use this screen to select the language displayed on the analyzer. The languages available for selection include: Danish, German, English, Dutch, Swedish and Finnish; or German, English, Spanish, French, Italian and Polish. The languages displayed depend on the model of the analyzer (refer to Table 1-1).

To select a language, first use the **ST** keys to move the cursor (**z**) in front of the desired language, and then press the **←** key.

Front Panel Key Functions:



– Move cursor (**z**) up



– Move cursor (**z**) down



– Select Language



– Go to Combustion Test Screen



– Go to Display Mode Setup Screen

4.16 Display Mode Setup Screen

(For PCA Models 30, 35, 60 & 65)

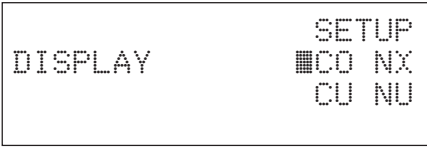

The Display Setup Screen is displayed by repeatedly pressing the **MENU** key from the Combustion Test Screen. Use this screen to select whether the Combustion Test Screen will display the measured values of Carbon Monoxide and Nitric Oxide (CO and NX), or the calculated values of these gases (CU and NU) referenced to 0% Oxygen.

To setup the display, first use the **st** keys to move the cursor (z) in front of either **CO NX** (measured values), or **CU NU** (calculated values), and then press the **←** key.

Front Panel Key Functions:



– Move cursor (z) up



– Move cursor (z) down



– Select Display Mode



– Go to Combustion Test Screen



– Go to Time/Date Setup Screen

4.17 Time/Date Setup Screen

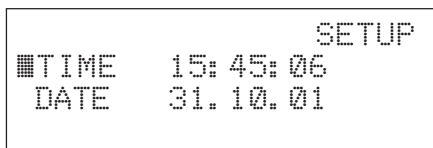

The Time/Date Setup Screen is displayed by repeatedly pressing the **MENU** key from the Combustion Test Screen. Use this screen to enter the current time and date.

To enter the correct time or date, first use the **st** keys to move the cursor (z) in front of the function you wish to change. Each position in the **TIME** or **DATE** number fields can then be changed by first pressing the **←** key to move the cursor into the desired position, then pressing the **st** keys to increase or decrease the value. Pressing **←** moves the cursor to the next position in the number field. Each individual position can be edited in the same manner. Once the time or date values have been entered, press **☐** to save the values and return the cursor to the left side of the screen.

Front Panel Key Functions:



– Move cursor (z) up, or Increase value in number fields



– Move cursor (z) down, or Decrease value in number fields



– Select Time or Date to be changed, or move cursor (z) to next position in the number field



– Go to the Combustion Test Screen, or save the time and date values and return the cursor to the left side of the display



– Go to Printer Setup Screen

4.18 Printer Setup Screen



The Printer Setup Screen is displayed by repeatedly pressing the **MENU** key from the Combustion Test Screen. Use this screen to choose the type of connection and printer being used.

- IR-HP: Infrared connection to a printer manufactured by Hewlett Packard, which uses their proprietary infrared communications protocol
- IR-IRDA: Infrared connection to a printer that uses a standard IrDA protocol
- RS232: Cable connection between the PCA and any serial printer capable of 9600 baud operation

Use the **st** keys to move the cursor (**z**) in front of the desired connection and printer, and then press the **←** key to make the selection and return to the Combustion Test Screen.

Front Panel Key Functions:



– Move cursor (**z**) up



– Move cursor (**z**) down



– Select connection and printer next to cursor



– Go to Combustion Test Screen



– Go to Maintenance Password Screen

4.19 Maintenance Password Screen

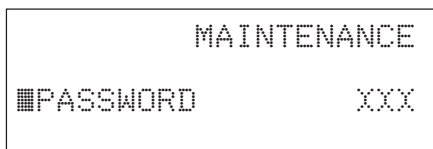





Where: xxx = Password number

The Maintenance Password Screen is displayed by repeatedly pressing the **MENU** key from the Combustion Test Screen. From here a three-digit password must be entered to access the instrument's Maintenance Screens. The password number is provided on the *Portable Combustion Analyzer Calibration Password* card that was supplied with the analyzer.

To enter the password, first press the \leftarrow key to move the cursor (z) into the first number field, and then press the \uparrow keys until the first digit of the password is displayed. Press \leftarrow to advance to the next number field and enter the second digit. Perform the same sequence a third time to complete the password. Press the \bullet key after the correct password is entered to display the Maintenance Screen.

Front Panel Key Functions:

-  – No action, or increase value in password number field
-  – No action, or decrease value in password number field
-  – Move cursor (z) to next position in password number field
-  – Go to Combustion Test Screen (if cursor is on left side of screen), or go to Maintenance Screen (if the proper password was entered), or return cursor to left side of screen (if the wrong password was entered)
-  – Go to Combustion Test Screen (if cursor is on left side of screen), or return cursor to left side of screen (if cursor is in the password number field)

4.20 Maintenance Screen

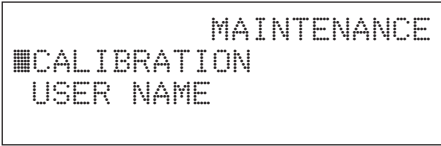

The Maintenance Screen is displayed after entering the correct password in the Maintenance Password Screen (Section 4.19). Use this screen to enter either the analyzer's Calibration Screen or User Name Screen.

To enter the Calibration Screen, first use the `st` keys to position the cursor (`z`) in front of `CALIBRATION`, and then press the `←` key.

NOTE: *Section 5.0 contains detailed calibration procedures.*

To enter the User Name Screen, first use the `st` keys to position the cursor (`z`) in front of `USER NAME`, and then press the `←` key.

Front Panel Key Functions:



– Toggle cursor (`z`) position



– Toggle cursor (`z`) position



– Select function next to cursor



– Go to Combustion Test Screen



– No action

4.21 User Name Screens

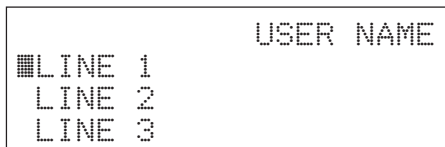

This initial User Name Screen is displayed after selecting USER NAME from the Maintenance Screen (Section 4.20). Use this screen to either enter or edit three lines of user-name information.

Each user-name line can be up to 20 alphanumeric characters in length. All three lines will appear at the top of each printout for the purpose of identifying the user or owner of the instrument (i.e., your company's name and address).

Front Panel Key Functions for Initial User Name Screen:



– Move cursor (z) upward



– Move cursor (z) downward



– Select Line Number that is next to the cursor for editing



– Go to Combustion Test Screen



– Return to Maintenance Screen

To enter text, first use the **st** keys to position the cursor (z) in front of the desired line number; then press **←**. The selected User Name Line Number Screen will then appear.

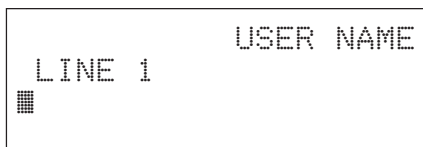

Now press the **st** keys until the desired letter or number is displayed. Available characters include:

“(space)ABCDEFGHIJKLMN OPQRSTUVWXYZ0000000123456789”

Press \leftarrow to save the selected character and advance to the next position. If you make a mistake, press \leftarrow until the cursor is over the wrong character and make your correction by again using the st keys.

After all the desired characters have been selected, press S to save the text line and return to the initial User Name Screen.

Front Panel Key Functions for Individual User Name Screens:



– Increment character



– Decrement character



– Select the displayed character and advance to the next character position



– Save the text line and return to the initial User Name Screen



– Abort any changes to the text line and return to the initial User Name Screen

4.22 Saving Test Data

```

O2   4.0 CO   12 HLD
C2   9.5 CU   15 NG
TL  20.0 TA  190 P
qA   8.1 LA  1.24 S
  
```

```

                                DRAFT
DRAFT   - 0.25 MB
HOT SPOT   190 °C P
                                S
  
```

To save the data displayed in either the Combustion Test or Draft Screens, first use the st keys to move the cursor (z) in front of the save (S) function and then press the \leftarrow key. The data will be saved in memory, and can be recalled at any time from the Memory Directory Screen (Section 4.10).

NOTE: *Data will be automatically stored in the next free memory location. After all memory locations are filled, any additional data that is saved will start overwriting previously saved data starting at the first memory location.*

4.23 Printing Test Data

```

O2   4.0 CO   12 HLD
C2   9.5 CU   15 NG
TL   20.0 TA  190 #P
qA   8.1 LA  1.24 S

```

```

                                DRAFT
DRAFT - 0.25 MB
HOT SPOT 190 °C #P
                                                S

```

Before printing, ensure that the correct connection and printer has been selected per Section 4.18.

The Print function is available in either the Combustion Test Screen or the Draft Screen*.

NOTE: *The data which is stored in memory can also be printed. First go to the Memory Directory Screen (Section 4.10) and display the data to be printed; then print the data as described below.*

When using an infrared printer:

1. Place analyzer in-line with the printer's IR input (see Figure 4-5).
2. Use the **st** keys to move the cursor (**z**) in front of the print (**⏏**) function.
3. Press the **←** key to start printing.

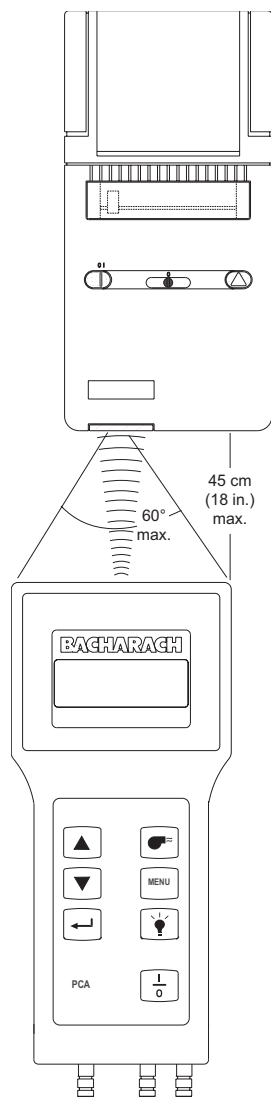

* The **HOT SPOT** line shown in the Draft Screen does not appear on the printout.

Figure 4-5. Aligning the Printer

When using a serial printer:

1. First connect the analyzer to the printer using the optional RS-232 cable (see Figure 4-6).
2. Set the printer's communication parameters to 9600 baud, 8 data bits, 1 stop bit, no parity, and no handshaking.
3. Use the **st** keys to move the cursor (**z**) in front of the print (**⏏**) function.
4. Press the **↵** key to start printing.

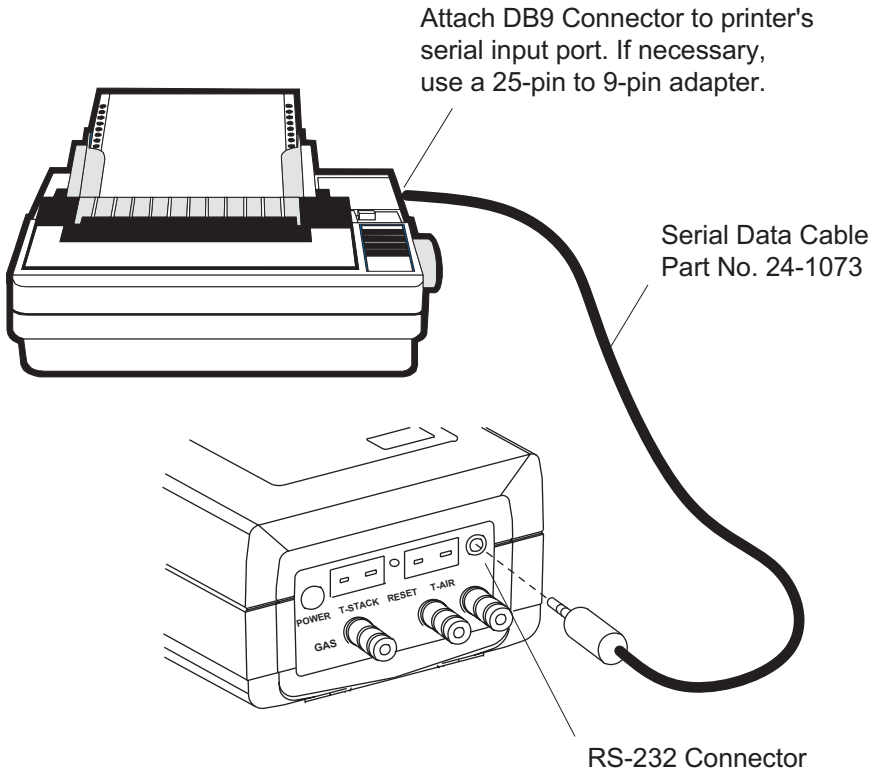
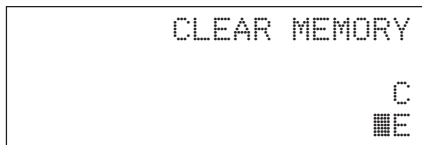

Figure 4-6. Connecting a Serial Printer to the Analyzer

4.24 Clear Memory Screen



The Clear Memory Screen is accessed from either the Memory Directory Screen (Section 4.10) or the Memory to PC Screen (Section 4.11).

To clear **all** memory locations, use the `st` keys to place the cursor (z) in front of the clear (C) function, and then press the `←` key.

To return to the previous screen without clearing any memory locations, use the `st` keys to place the cursor (z) in front of the exit (E) function; then press `←`.

4.25 Resetting the Microprocessor

If the analyzer “locks-up” and cannot be turned OFF, reset the microprocessor by pressing the RESET button (Figure 4-7). The button can be activated using the end of a paper clip.

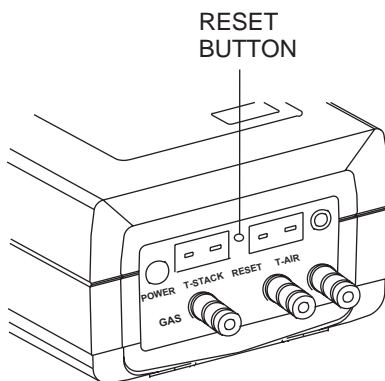

Figure 4-7. Reset Button

NOTES:

5.0 CALIBRATION

NOTE: *Bacharach recommends that the PCA be calibrated by your nearest Bacharach Service Center. Calibration, however, can be performed in the field if your facility has the necessary equipment and qualified personnel to perform the procedures described in the sections that follow.*

IMPORTANT! *To prevent the loss of data during calibration, perform the following procedures with fresh batteries, or using an optional Power Supply (see Section 3.2).*

5.1 Sensor Check

IMPORTANT! *Before turning on the analyzer or performing any of the calibration procedures, ensure that the analyzer will be sampling fresh air, and that the probe is at room temperature.*

When the analyzer is first turned on and allowed to cycle through its 60 second warmup period, and while sampling fresh air, the sensors are checked (read) and calibrated (set) to the following ambient conditions:

- Oxygen sensor is spanned to 20.9%
- Carbon Monoxide sensor (if installed) is zeroed
- Nitric Oxide sensor (if installed) is zeroed
- Pressure sensor (if installed) is zeroed

5.2 Calibration Fixtures

A gas and a draft fixture will be required to perform the various calibration procedures described in this manual.

Material Required:

- Calibration Kit (Refer to Section 8.2)
- Calibration Gas Cylinder (Refer to Section 8.2)
- Bellows
- Micromanometer

Procedure:

Assemble the appropriate fixture, shown in Figure 5-1, as required by the calibration procedure being performed.

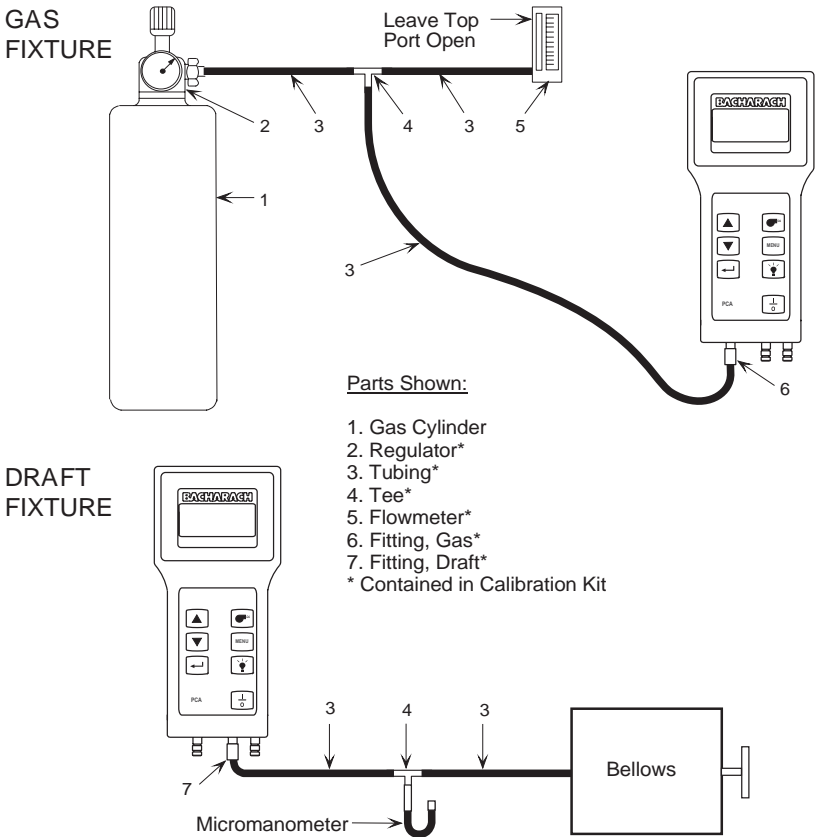

Figure 5-1. Calibration Fixtures

5.3 Calibrate Menu Screen

■ TA-ZERO	CALIBRATE
TA-SPAN	NX
TL-ZERO	CO
TL-SPAN	DRAFT

The Calibrate Menu Screen is displayed after entering the correct password in the Maintenance Password Screen (Section 4.19) and selecting CALIBRATION from the Maintenance Screen (Section 4.20). Use this screen to select the sensor to be calibrated.

Press the **st** keys until the cursor (z) is in front of the desired function, and then press the **←** key.

NOTE: *TA is the stack temperature sensor, while TL is the optional Room Air/Primary Air temperature sensor.*

NOTE: *If a sensor is not installed (i.e., the instrument does not have a Nitric Oxide sensor or thermocouple simulator installed), the corresponding calibration screen will not be displayed.*

Front Panel Key Functions:



– Move cursor (z) up



– Move cursor (z) down



– Select sensor to be calibrated



– Go to Combustion Test Screen



– Return to Maintenance Screen

5.4 Calibrate TA-Zero

Material Required:

- Thermocouple Simulator (K-type) Range: 0 to 300°C
Accuracy: $\pm 0.3^\circ\text{C}$

Procedure:

1. With the analyzer turned off, first plug the simulator's K-type connector into the T-STACK jack (Figure 3-2); then turn on the analyzer and wait for its warmup cycle to complete.
2. Enter the Calibration Menu Screen per Section 5.3; then choose TA-ZERO to zero the analyzer's stack temperature channel.
3. Adjust the simulator to 0° C (32° F).*
4. Wait until the MEASURED reading on the screen stabilizes. Then use the `st` and `←` keys to enter an APPLIED value that equals 0 °C (32 °F).

Typical Calibrate TA-Zero Screen During Calibration Procedure:

```

CALIBRATE TA-ZERO
MEASURED      3.0°C
APPLIED      0000.0°C
  
```

4. Press the `☐` key to calibrate the analyzer's MEASURED value to that of the APPLIED value. At this time the Calibrate Menu Screen is redisplayed.

* The calibration range for this screen is 0 – 5 °C (32 – 41°F). Any attempt to calibrate outside this range will cause the analyzer to display an error message.

5.5 Calibrate TA-Span

Material Required:

- Thermocouple Simulator (K-type) Range: 0 to 300°C
Accuracy: $\pm 0.3^\circ\text{C}$

Procedure:

1. With the analyzer turned off, first plug the simulator's K-type connector into the T-STACK jack (Figure 3-2); then turn on the analyzer and wait for its warmup cycle to complete.
2. Enter the Calibration Menu Screen per Section 5.3; then choose TA-SPAN to span the analyzer's stack temperature channel.
3. Set the simulator to 300° C (572° F).*
4. Wait until the MEASURED reading on the screen stabilizes. Then use the `st` and `←` keys to enter an APPLIED value that equals 300 °C (572 °F).

Typical Calibrate TA-Span Screen During Calibration Procedure:

```
CALIBRATE TA-SPAN
MEASURED      295.0°C
APPLIED       0300.0°C
```

4. Press the `↵` key to calibrate the analyzer's MEASURED value to that of the APPLIED value. At this time the Calibrate Menu Screen is redisplayed.

* The calibration range for this screen is 270 – 330 °C (518 – 626 °F). Any attempt to calibrate outside this range will cause the analyzer to display an error message.

5.6 Calibrate TL-Zero

Material Required:

- Thermocouple Simulator (K-type) Range: 0 to 300°C
Accuracy: $\pm 0.3^\circ\text{C}$

Procedure:

1. With the analyzer turned off, first plug the simulator's K-type connector into the T-AIR jack (Figure 3-2); then turn on the analyzer and wait for its warmup cycle to complete.
2. Enter the Calibration Menu Screen per Section 5.3; then choose TL-ZERO to zero the analyzer's room-air/primary-air temperature channel.
3. Set the simulator to 0 °C (32 °F).*
4. Wait until the MEASURED reading on the screen stabilizes. Then use the `st` and `←` keys to enter an APPLIED value that equals 0 °C (32 °F).

Typical Calibrate TL-Zero Screen During Calibration Procedure:

```
CALIBRATE TL-ZERO
MEASURED      3.0°C
APPLIED      0000.0°C
```

4. Press the `☐` key to calibrate the analyzer's MEASURED value to that of the APPLIED value. At this time the Calibrate Menu Screen is redisplayed.

* The calibration range for this screen is 0 – 5 °C (32 – 41 °F). Any attempt to calibrate outside this range will cause the analyzer to display an error message.

5.7 Calibrate TL-Span

Material Required:

- Thermocouple Simulator (K-type) Range: 0 to 300°C
Accuracy: $\pm 0.3^\circ\text{C}$

Procedure:

1. With the analyzer turned off, first plug the simulator's K-type connector into the T-AIR jack (Figure 3-2); then turn on the analyzer and wait for its warmup cycle to complete.
2. Enter the Calibration Menu Screen per Section 5.3; then choose TL-SPAN to span the analyzer's room-air/primary-air temperature channel.
3. Set the simulator to 100 °C (212 °F).*
4. Wait until the MEASURED reading on the screen stabilizes. Then use the `st` and `←` keys to enter an APPLIED value that equals 100 °C (212 °F).

Typical Calibrate TL-Span Screen During Calibration Procedure:

```

CALIBRATE TL-SPAN
MEASURED      102.0°C
APPLIED       0100.0°C
  
```

4. Press the `↵` key to calibrate the analyzer's MEASURED value to that of the APPLIED value. At this time the Calibrate Menu Screen is redisplayed.

* The calibration range for this screen is 90 – 110 °C (194 – 230 °F). Any attempt to calibrate outside this range will cause the analyzer to display an error message.

5.8 Calibrate NX

(For PCA Models 30, 35, 60 & 65)

The Nitric Oxide sensor needs to be spanned at regular intervals to determine that it still meets its accuracy specification. Because of the toxicity of Nitric Oxide gas, however, unless your facility has the necessary gas cylinders and personnel trained in the handling of toxic gases, we recommend that the Nitric Oxide sensor be spanned by an authorized Bacharach Service Center.

Material Required:

- Calibration Gas Fixture (Section 5.2)
- Gas Cylinder, 50 to 150 ppm Nitric Oxide with an analytical accuracy of $\pm 1\%$ (customer supplied)

Procedure:

1. Enter the Calibrate Menu Screen per Section 5.3. Then choose to calibrate the NX sensor.
2. At the conclusion of Step 1 the pump should start running.
3. Using the Gas Fixture shown in Figure 5-1, attach the Nitric Oxide calibration-gas cylinder to the analyzer's GAS inlet.
4. Adjust the regulator of the calibration fixture for a flowmeter indication of approximately 2 SCFH.
5. Wait until the MEASURED reading on the screen stabilizes (approximately 3 minutes). Then use the **st** and **←** keys to enter an APPLIED value* that equals the concentration that is stamped on the NX calibration-gas cylinder.

Typical Calibrate NX Screen During Calibration, Using 100 ppm Nitric Oxide Calibration Gas:

CALIBRATE NX	
MEASURED	092 PPM
APPLIED	0100 PPM

6. Press the **☐** key to calibrate the analyzer's MEASURED value to that of the APPLIED value. At this time the Calibrate Menu Screen is redisplayed.

* The calibration range for this screen is 50 – 150 ppm. Any attempt to calibrate outside range will cause the analyzer to display an error message.

5.9 Calibrate CO

(For PCA Models 20, 25, 30, 35, 50, 55, 60 & 65)

Material Required:

- Calibration Gas Fixture (Section 5.2)
- Gas Cylinder, 500 ppm CO in air (Refer to Section 8.2)
- Gas Cylinder, CO (1000 ppm) and H₂ (1000 ppm) in Nitrogen (Refer to Section 8.2)

Procedure:

1. Enter the Calibrate Menu Screen per Section 5.3. Then choose to calibrate the CO sensor.
2. At the conclusion of Step 1 the pump should start running.
3. Using the Gas Fixture shown in Figure 5-1, attach the CO calibration-gas cylinder to the analyzer's GAS inlet.
4. Adjust the regulator of the calibration fixture for a flowmeter indication of approximately 2 SCFH.
5. Wait until the MEASURED reading on the screen stabilizes (approximately 3 minutes). Then use the **st** and **←** keys to enter an APPLIED value* that equals the concentration which is stamped on the CO calibration-gas cylinder.

Typical CALIBRATE CO Screen During Calibration Procedure, Using 500 ppm CO Calibration Gas:

CALIBRATE CO	
MEASURED	492 PPM
APPLIED	0500 PPM

6. Press the **↻** key to calibrate the analyzer's MEASURED value to that of the APPLIED value. At this time the Test Gas CO/H₂ Screen is displayed.

* The calibration range for this screen is 250 – 1500 ppm. Any attempt to calibrate outside this range will cause the analyzer to display an error message.

7. Turn off the flow of CO calibration-gas; then remove the calibration-gas cylinder from the calibration fixture.
8. Attach a CO/H₂ calibration-gas cylinder to the calibration fixture; then adjust the regulator of the calibration fixture for a flowmeter reading of approximately 2 SCFH.
9. Use the `st` and `←` keys to enter a CO-VALUE that is the same as the CO concentration which is stamped on the CO/H₂ calibration-gas cylinder.

Typical Test Gas CO/H2 Screen During Calibration Procedure:

```

TEST GAS CO/H2
-----
CO-VALUE      XXXX
ENTER CO-VALUE
  
```

10. Press the `☐` key to save the CO-VALUE and display the Calibrate H2 Screen.
11. After calibration gas has been applied for approximately 3 minutes (to allow for stabilization), use the `st` and `←` keys to enter an APPLIED value* that equals the H₂ concentration stamped on the CO/H₂ calibration-gas cylinder.

Typical CALIBRATE H2 Screen During Calibration Procedure:

```

CALIBRATE H2
MEASURED      1050 PPM
APPLIED       1000 PPM
  
```

12. Press the `☐` key to calibrate the analyzer's MEASURED value to that of the APPLIED value. At this time the Calibrate Menu Screen is redisplayed.

* The calibration range for this screen is 500–1500 ppm, any attempt to calibrate outside this range will cause the unit to display an error message.

5.10 Calibrate Draft

(For PCA Models 15, 25, 35, 45, 55 & 65)

Material Required:

- Calibration Fixture (Section 5-2)
- Bellows (adjustable)
- Micromanometer Range: ± 20 mb (± 8 in. H₂O column)
 Accuracy: ± 0.025 mb (± 0.01 in. H₂O column)

Procedure:

IMPORTANT! *In Step 1, **do not** connect the draft calibration fixture to the analyzer until the Calibrate Draft Screen has been selected and displayed.*

1. Enter the Calibrate Menu Screen per Section 5.3. Then choose to calibrate the draft sensor.
2. With the Calibrate Draft Screen displayed, connect the hose from the calibration fixture to the analyzer's DRAFT port; then adjust the bellows for a micromanometer reading of -10 mb ($-4''$ H₂O column).
3. Wait until the MEASURED reading on the screen stabilizes. Then use the **st** and **←** keys to enter an APPLIED reading* which equals the Micromanometer reading.

Typical CALIBRATE DRAFT Screen During Calibration Procedure:

CALIBRATE DRAFT	
MEASURED	- 9.00 MB
APPLIED	-10.00 MB

4. Press the **↻** key to calibrate the analyzer's MEASURED value to that of the APPLIED value. At this time the Calibrate Menu Screen is redisplayed.
5. When all desired calibrations have been completed, press **↻** to exit to the Combustion Test Screen.

* The calibration range for this screen is -5 to -15 mb, any attempt to calibrate outside this range will cause the unit to display an error message.

NOTES:

6.0 MAINTENANCE

6.1 Routine Maintenance

Routine maintenance of the analyzer consists of: replacing the batteries, cleaning the probe, draining the water trap, replacing the water trap filter, and performing periodic calibration checks to ensure that the analyzer is providing accurate readings.

- Replace the Batteries per Section 3.2.
- Clean the Probe per Section 6.3.
- Maintain the Water Trap/Filter Assembly per Section 6.4.
- Replace the Particulate Filter per Section 6.5
- Calibrate the analyzer per Section 5.0.

6.2 Disassembly

Perform the following when a maintenance procedure calls for removing the case, printed circuit board, pump, or sensors:

1. Remove the batteries (Section 3.2.1)
2. Place the analyzer face down on a work surface, then remove the unit's four rear-case screws.
3. Carefully lift the rear case from the analyzer, unplug the battery compartment wires, then place the rear housing on a work surface (see Figures 6-1 & 6-2).

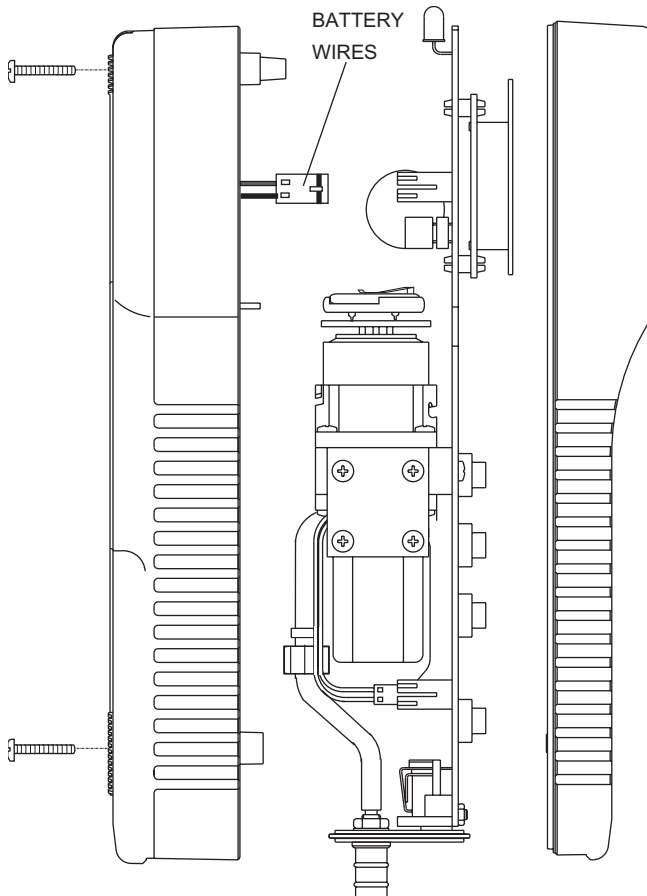

Figure 6-1. Disassembling the Analyzer

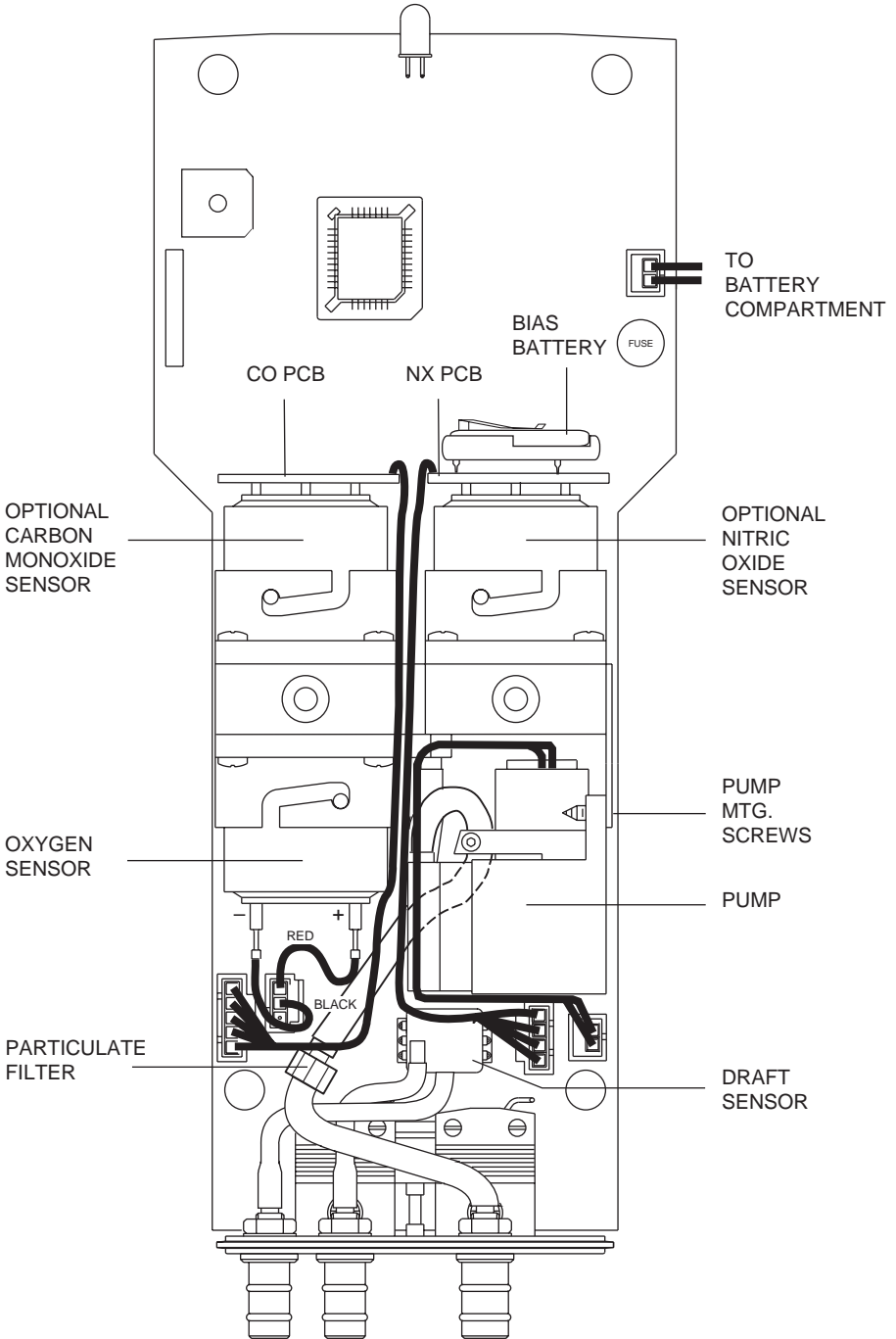

Figure 6-2. Rear View of the PCB and Sensors

6.3 Cleaning the Probe

The Probe Tube and the Probe Body will become dirty under normal use (the water trap's filter element should prevent soot from reaching the analyzer's internal components). If the probe assembly is not kept clean, it could become clogged and restrict the flow of gas to the analyzer, resulting in incorrect readings and calculations.

NOTE: *An analyzer that is used to sample natural-gas furnaces normally requires less frequent cleaning than an analyzer used to sample oil or coal fired furnaces.*

Equipment Required:

- Alcohol
- Aerosol can of Automotive Carburetor Cleaner
- Clean Rag
- Source of Compressed Air (optional)

Procedure:

1. Remove the rubber tubing from the barbed fitting(s) on the probe handle (Figure 3-2).

CAUTION:

Carburetor cleaner attacks plastic components. Take precautions not to spray cleaner onto the probe handle or analyzer.

2. Insert the plastic-spray tube of the carburetor cleaner into the barbed fitting(s) of the probe handle; then liberally spray carburetor cleaner through the probe.
3. After spraying, remove all the residual cleaner by repeatedly flushing the probe with alcohol.
4. Wipe off the surfaces of the probe and tubing with a clean rag.
5. Allow the parts to dry completely. If available, blow compressed air through the probe to expedite the drying process.
6. Reassemble the parts of the probe assembly.

6.4 Water Trap/Filter Assembly Maintenance

The Water Trap / Filter Assembly removes water condensate from the gas sample, and also prevents soot from contaminating the internal components of the analyzer.

Drain the water condensate after every use.

Procedure:

1. Pull off the end-cap from the Inlet End of the Water Trap / Filter Assembly (Figure 6-3).
2. Pour out all of the water condensate, and replace the end-cap.

Replace the filter element when it becomes excessively dirty.

Equipment Required:

- Filter Element (Refer to Section 8.0)

Procedure:

1. Pull off the end-cap from the Outlet End of the Water Trap / Filter Assembly (Figure 6-3).
2. Remove and discard the old filter element.
3. Install a new filter element and replace the end-cap.

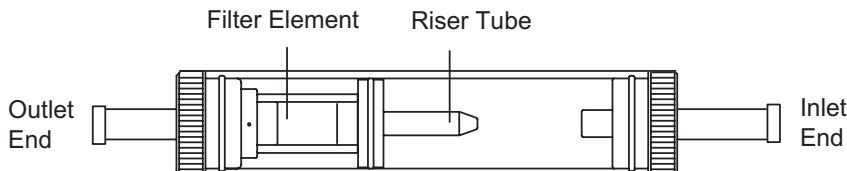

Figure 6-3. Water Trap/Filter Assembly

6.5 Replacing the Particulate Filter

The internal particulate filter (Figure 6-2) prevents small dust and dirt particles from entering and damaging the pump. Depending on your environmental conditions, it is recommended to change the particulate filter and fitting approximately every six months, or sooner if it becomes blocked.

Equipment Required:

- Particulate Filter and Fitting (Refer to Section 8.0)

Procedure:

1. Remove the analyzer's rear case and lay it aside (refer to Section 6.2).
2. Carefully pull off the tubing from the filter and fitting. Note the orientation of tubing and fitting before removing.
3. Remove and discard the old filter and fitting and replace with new ones. Be careful not to not pinch the tubing during reassembly.
4. Reassemble the analyzer in the reverse order of disassembly.

6.6 Replacing the Oxygen Sensor

Replace the Oxygen Sensor when it has expired (when the analyzer's automatic O₂ calibration fails and the unit displays the message "O₂-Sensor Error").

NOTE: A "O₂-SENSOR ERROR" displayed in the Sensor Status Screen does not necessarily mean that the sensor has expired. Before replacing the sensor, refer to Section 7.2 for other possible causes of the error.

Equipment Required:

- Small Flat Blade Screw Driver
- Oxygen Sensor (Refer to Section 8.0)

Procedure:

1. Remove the analyzer's rear case and lay it aside (refer to Section 6.2).
2. Remove the Oxygen Sensor connector from the printed circuit board; then carefully pull off the two wires connected to the pins of the sensor (see Figure 6-2).
3. Push in and turn the sensor counterclockwise (watching the notch on top) until it stops; then pull the sensor out of its housing.
4. To install a new sensor, push the sensor into the housing and turn it clockwise until it locks in place.
5. Connect the black (-) and red (+) wires, which were removed from the old sensor in Step 2, to the pins of the new sensor. Be sure to observe polarity as marked on the sensor.
6. Reinstall the sensor connector onto the printed circuit board.
7. Reassemble the analyzer. Then allow the sensor to be connected in the circuit for at least *1 hour* before continuing.
8. Place the analyzer in an area of fresh air and turn it ON. After the warmup cycle, observe that the Sensor Status Screen should not show an O₂ sensor error.

6.7 Replacing the Nitric Oxide Sensor

(For PCA Models 30, 35, 60 & 65)

Replace the Nitric Oxide sensor when it has expired (can no longer be calibrated).

NOTE: A "NX-SENSOR ERROR" displayed in the Sensor Status Screen does not necessarily mean that the sensor has expired. Before replacing the sensor, refer to Section 7.2 for other possible causes of the error.

Equipment Required:

- Small Flat Blade Screw Driver
- Nitric Oxide Sensor (Refer to Section 8.0)
- Nitric Oxide Sensor Filter (Refer to Section 8.0)

Procedure:

1. Remove the analyzer's rear case and lay it aside (refer to Section 6.2).
2. Carefully pull the printed circuit board off the rear of the Nitric Oxide sensor (see Figure 6-2).
3. Push in and turn the sensor counterclockwise (watching the notch on top) until it stops; then pull the sensor out of its housing.
4. Install a new sensor by first pushing it into its housing, and then turning it clockwise until it locks in place.
5. Install the circuit board, which was removed in Step 2, onto the rear of the sensor.
6. Reassemble the analyzer and allow the sensor to be connected in the circuit for at least *4 hours* before continuing.
7. Place the analyzer in an area of fresh air and turn it ON.
8. Calibrate the analyzer per Section 5.0.

6.7.1 Replacing the Nitric Oxide Sensor Filter

Replacing the orange filter on the Nitric Oxide sensor once a year could increase the life of the sensor.

Procedure:

1. Remove the Nitric Oxide sensor per Section 6.7.
2. Pry the orange filter from the Nitric Oxide sensor and replace it with a new one.
3. Reinstall the sensor.

6.7.2 Replacing the Nitric Oxide Sensor Bias Battery

A single lithium battery, located on the Nitric Oxide printed circuit board (see Figure 6-2), applies a constant bias voltage to the Nitric Oxide sensor even while the instrument is turned off. This battery has a life expectancy of at least 2 years.

Replace the Nitric Oxide bias battery toward the end of its expected life.

Equipment Required:

- Bias Battery (See Section 8.0)

Procedure:

1. Remove the analyzer's rear case and lay it aside (refer to Section 6.2).
2. Remove old battery from its holder (see Figure 6-2).
3. Insert the new battery (positive side facing upwards) into its holder.
4. Reassemble the analyzer.
5. Before powering up and using the instrument, allow the Nitric Oxide sensor to stabilize as described below. Recalibration of the Nitric Oxide sensor is usually not required.

Depending on how long the Nitric Oxide sensor was without bias voltage, the time required for the sensor to completely stabilize varies from less than a minute to several days. Typical stabilization times are shown below. Generally, however, the sensor is sufficiently stable after 4 hours for measurement purposes.

Bias removed for. .	Stabilization time
Less than 15 min.	Less than 1 min.
Less than 1 hr.	Less than 5 min.
Less than 2 days	Less than 4 hr.
Greater than 2 days	Up to 2 days

6.8 Replacing the Carbon Monoxide Sensor

(For PCA Models 20, 25, 30, 35, 50, 55, 60 & 65)

Replace the Carbon Monoxide sensor when it has expired (can no longer be calibrated).

NOTE: A "*CO-SENSOR ERROR*" displayed in the Sensor Status Screen does not necessarily mean that the sensor has expired. Before replacing the sensor, refer to Section 7.2 for other possible causes of the error.

Equipment Required:

- Small Flat Blade Screw Driver
- Carbon Monoxide Sensor (Refer to Section 8.0)
- Carbon Monoxide Sensor Filter (Refer to Section 8.0)

Procedure:

1. Remove the analyzer's rear case and lay it aside (refer to Section 6.2).
2. Carefully pull the printed circuit board off the rear of the Carbon Monoxide sensor (see Figure 6-2).
3. Push in and turn the sensor counterclockwise (watching the notch on top) until it stops; then pull the sensor out of its housing.
4. Remove the wire jumper from the pins of the new sensor.
5. Install the new sensor by first pushing the sensor into its housing, and then turning clockwise until it locks in place.
6. Install the circuit board, which was removed in Step 2, onto the rear of the sensor.
7. Reassemble the analyzer; then allow the sensor to be connected in the circuit for at least *1 hour* before continuing.
8. Place the analyzer in an area of fresh air and turn it ON.
9. Calibrate the analyzer per Section 5.0.

6.8.1 Replacing the Carbon Monoxide Sensor Filter

Replacing the red filter on the Carbon Monoxide sensor once a year could increase the life of the sensor.

Procedure:

1. Remove the Carbon Monoxide sensor per Section 6.8.
2. Pry the red filter from the Carbon Monoxide sensor and replace it with a new one.
3. Reinstall the sensor.

6.9 Replacing the Pump Assembly

Replace the Pump Assembly if it is found to be defective.

Equipment Required:

- Small Flat Blade Screw Driver
- No. 1 Phillips Screw Driver
- Pump Assembly (Refer to Section 8.0)

Procedure:

1. Remove the analyzer's rear case and lay it aside (refer to Section 6.2).
2. Remove the two self tapping Phillips screws holding the Pump Assembly (See Figure 6-1).
3. Unplug the pump connector from the printed circuit board; slide off the two hoses from the pump noting their orientation; then remove the entire assembly.
4. Install the new assembly and reassemble the analyzer in the reverse order of disassembly.

7.0 TROUBLESHOOTING

7.1 Analyzer Repair

It is recommended that field repair of the PCA be limited to:

- Simple checks of the printed circuit boards
- Replacing the Probe Assembly
- Replacing the filter element in the Water Trap / Filter Assembly
- Replacing the Particulate Filter
- Replacing the Pump Assembly
- Replacing Sensors and Sensor Filters
- Replacing Batteries

All other repairs should be performed by an authorized Bacharach Service Center. Any repairs performed by an *unauthorized* service organization will void the analyzer's warranty and release Bacharach, Inc. of any implied or written product liability.

Before returning your analyzer for repair, you may be able to determine and resolve a problem using the Troubleshooting Guide in Section 7.3.

7.2 Error Codes

If one of the following messages appear at the bottom of the Sensor Status Screen, refer to Section 7.3 Troubleshooting Guide for information on how to correct the error.

O ₂ - SENSOR ERROR	O ₂ Sensor not connected, or is expired, or was exposed to combustion gases during warmup.
CO - SENSOR ERROR	Carbon Monoxide sensor is expired, or was exposed to Carbon Monoxide during warmup.
NX - SENSOR ERROR	Nitric Oxide sensor is expired, or was exposed to Nitric Oxide during warm up, or the bias battery is dead.
TL-SENSOR ERROR	Room air thermocouple is outside the range of -20 to 100 °C (-4 to 212 °F)
TA-SENSOR ERROR	Flue Gas thermocouple is not connected or is outside the range of -20 to 1200 °C (-4 to 2192 °F)
DRAFT-SENSOR ERROR	Outside the range of -7.5 to +7.5 mb (-3 to +3 inches of water column)
LOW BATTERY	Battery voltage has dropped below 3.9 volts. The instrument will shut off when battery voltage drops below 3.5 volts.
“_ _ _ _”	Not calculated (O ₂ above 18.8%, or the temperature is above 1200 °C (2192 °F), or sensor error
“* * * *”	Sensor not installed
“XXXX”	Overrange (numeric)

7.3 Troubleshooting Guide

The following table lists the causes and remedies for most of the problems that may arise with the analyzer. For help with any problem not discussed here, contact your nearest Bacharach Service Center.

TABLE 7-1. TROUBLESHOOTING GUIDE

Fault	Probable Cause & Remedy
Analyzer completely nonfunctional; won't turn on when the $\frac{1}{6}$ key is pressed.	<ul style="list-style-type: none"> a. Batteries dead. Replace batteries per Section 3.2. b. Loose battery connector. Disassemble analyzer and ensure that the battery connector is attached to the printed circuit board. c. Microprocessor needs to be reset. Press RESET button (Fig. 4-7). d. Optional Power Supply defective. Replace Power Supply. e. Analyzer defective. Return to Bacharach for repair.
Display Screen is blank when analyzer is turned on, but pump runs during warmup cycle.	<ul style="list-style-type: none"> a. Microprocessor needs to be reset. Press RESET button (Fig. 4-7). b. Analyzer defective. Return to Bacharach for repair.
LOW BATTERY message appears at bottom of display.	Batteries close to being discharged. Analyzer will run for several minutes before the instrument shuts off. Replace batteries per Section 3.2.1.
O₂-SENSOR ERROR code appears in the Sensor Status Screen.	<ul style="list-style-type: none"> a. Calibration was attempted while sampling combustion gases. b. O₂ sensor is either expired, not wired correctly, or not connected to the circuit board. Replace or check wiring of sensor per Section 6.6.

TABLE 7-1. TROUBLESHOOTING GUIDE (Cont.)

Fault	Probable Cause & Remedy
<p>NX-SENSOR ERROR code appears in the Sensor Status Screen.</p>	<ul style="list-style-type: none"> a. Calibration was attempted while sampling combustion gases. b. Nitric Oxide sensor is expired. Replace sensor per Section 6.7. c. Bias battery on the Nitric Oxide circuit board is dead. Replace battery per Section 6.7.2.
<p>CO-SENSOR ERROR code appears in the Sensor Status Screen.</p>	<ul style="list-style-type: none"> a. Calibration was attempted while sampling combustion gases. b. Carbon Monoxide sensor is expired. Replace sensor per Section 6.8.
<p>DRAFT-SENSOR ERROR code appears in the Sensor Status Screen.</p>	<ul style="list-style-type: none"> a. Sensor is exposed to pressure outside of its detectable range. b. Sensor defective. Return analyzer to Bacharach for repair.
<p>TA-SENSOR OR TL-SENSOR ERROR code appears in the Sensor Status Screen.</p>	<ul style="list-style-type: none"> a. Calibration was attempted while sampling combustion gases. b. Thermocouple defective. Replace probe assembly. c. Thermocouple not connected. Connect thermocouple to analyzer per Section 3.3. d. Instrument exposed to temperature outside it's allowable operating temperature.
<p>"****" appears in one or more value fields.</p>	<p>The field's associated sensor is not installed.</p>

TABLE 7-1. TROUBLESHOOTING GUIDE (Cont.)

Fault	Probable Cause & Remedy
<p>“- - - -” appears in one or more value fields of the Combustion Test Screen.</p>	<p>a. The analyzer is not able to calculate a numerical value based on measured combustion data. The “- - - -” is replaced with numerical values when the analyzer begins to detect valid combustion data.</p> <p>b. Sensor in error during warm-up.</p>
<p>“XXXX” appears in one or more value fields.</p>	<p>The field’s associated sensor is detecting a value that is outside the analyzer’s detection range. “XXXX” is replaced with numerical data when the analyzer detects values that fall within its range.</p>
<p>Analyzer won’t respond when a panel key is pressed.</p>	<p>Microprocessor needs to be reset. Press RESET button (Fig. 4-7).</p>
<p>Pump motor sounds sluggish, stalls, or won’t start.</p>	<p>a. Flow restricted. Check that the filter element in the Water Trap/ Filter Assembly is clean and not saturated with water. Also, verify that the probe hose tubing is not pinched (Fig. 6-3).</p> <p>b. Flow restricted. Check the Particulate Filter is clean and not blocked (Fig. 6-2).</p> <p>c. Loose pump connection. Disassemble analyzer and ensure that the pump connector is securely attached to the circuit board</p> <p>d. Pump defective. Replace pump assembly.</p>

TABLE 7-1. TROUBLESHOOTING GUIDE (Cont.)

Fault	Probable Cause & Remedy
Backlight won't turn on.	Backlight LED burned out. Return to Bacharach for repair.
Batteries do not last 10 hours.	Cold temperature is reducing battery capacity. To obtain longer operating time, keep analyzer warm.
Erratic Combustion Test Screen values.	<p>a. Faulty sensor(s):</p> <ul style="list-style-type: none"> - Check that the sensors are properly installed per Sections 6.6 through 6.8. - Check sensor calibration per Section 5.0. - Replace sensor(s) and recalibrate per Sections 5.0 and 6.0. <p>b. Probe assembly leaking. Check tightness of all hose connections and integrity of tubing.</p> <p>c. Pump defective. Replace pump & motor assembly.</p> <p>d. Analyzer defective. Return to Bacharach for repair.</p>
Analyzer will not calibrate properly.	<p>a. Wrong calibration gas or insufficient flow being applied to sensor. Ensure your calibration setup is correct.</p> <p>b. Faulty sensor. Replace sensor and recalibrate per Sections 5.0 and 6.0.</p> <p>c. Analyzer defective. Return to Bacharach for repair.</p>

8.0 PARTS & SERVICE

8.1 Replacement Parts

Item Figures 8-1, 2 & 3	Description	Part No.
1	Battery Cover	24-0784
2	Screw, Case Housing	501-3824
3	Screw, Pump Mounting	501-3822
8	Oxygen Sensor	24-0788
9	Carbon Monoxide Sensor	24-0789
10	Nitric Oxide Sensor	24-0881
11	Carbon Monoxide Sensor Filter	24-0863
12	Nitric Oxide Sensor Filter	24-0862
13	Pump Assembly	24-3009
14	Fuse	604-2605
15	Battery, Nitric Oxide Sensor Bias	204-0020
18	Filter Element (white)	07-1644
19	Draft Connector, Probe	24-0878
20	Gas Connector, Probe	24-0877
21	O-Ring, 7mm OD x 1mm wall	105-5103
22	O-Ring, 8mm OD x 1mm wall	105-5102
23	Particulate Filter	07-1600
24	Fitting, for Particulate Filter	103-5267
25	Filter Assembly (complete)	24-1107

8.2 Accessories

Description	Part No.
STANDARD ACCESSORIES:	
Battery, "AA" Alkaline	204-0004
Complete Probe and Hose Assembly (Gas & Draft)	24-3004
Instruction Manual	24-9351
Plastic Carrying Case	24-1078
OPTIONAL ACCESSORIES:	
Ambient Thermocouple, 10 ft. K-type	104-1797
Ambient Thermocouple, 1 in. K-type	104-1798
Bent Probe Tip	24-8039
Calibration Kit	24-7059
Differential Pressure Hose Assembly	24-1103
Gas Cylinder, 1000 ppm CO, 1000 ppm H ₂ , in Nitrogen	24-0794
Gas Cylinder, 500 ppm CO	24-0492
Printer, IrDA (with battery charger):	
120 VAC	24-1229
230 VAC	24-1230
Printer Paper, Thermal (1 roll)	06-8733
Power Supply Adapter, 110 VAC	24-0885
Regulated Power Supply Adapter, 230 VAC	24-1209
Serial Cable	24-1073

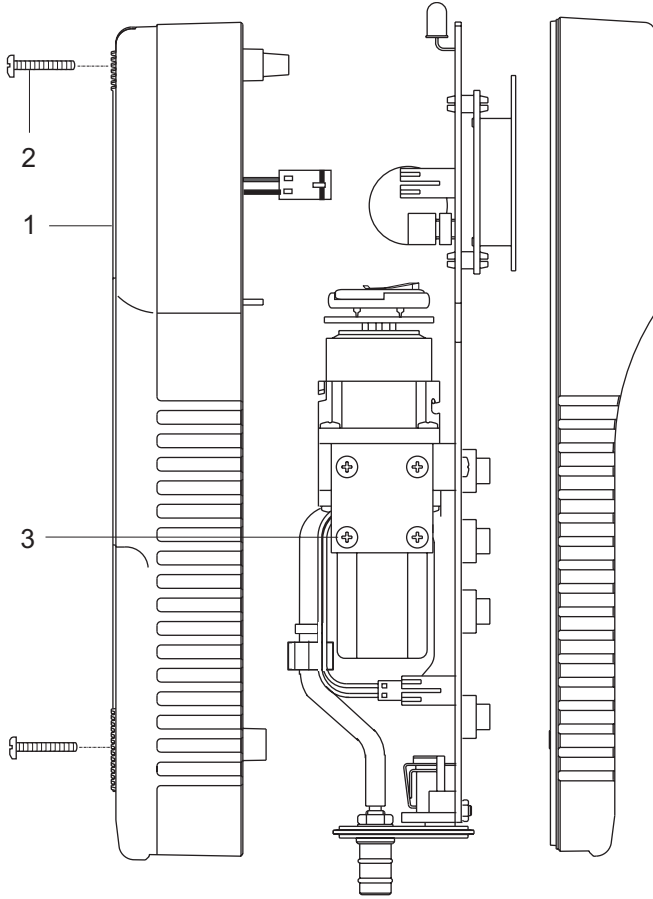

Figure 8-1. Replacement Parts

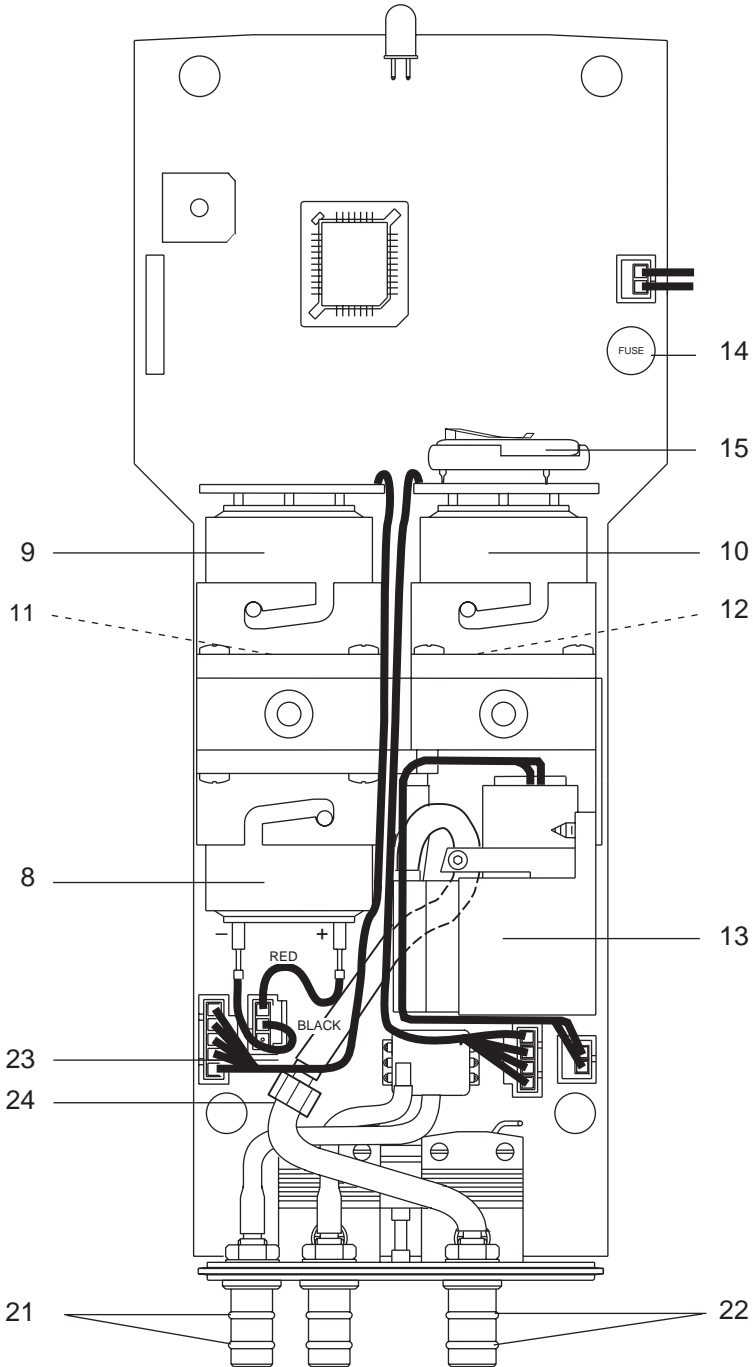

Figure 8-2. Replacement Parts

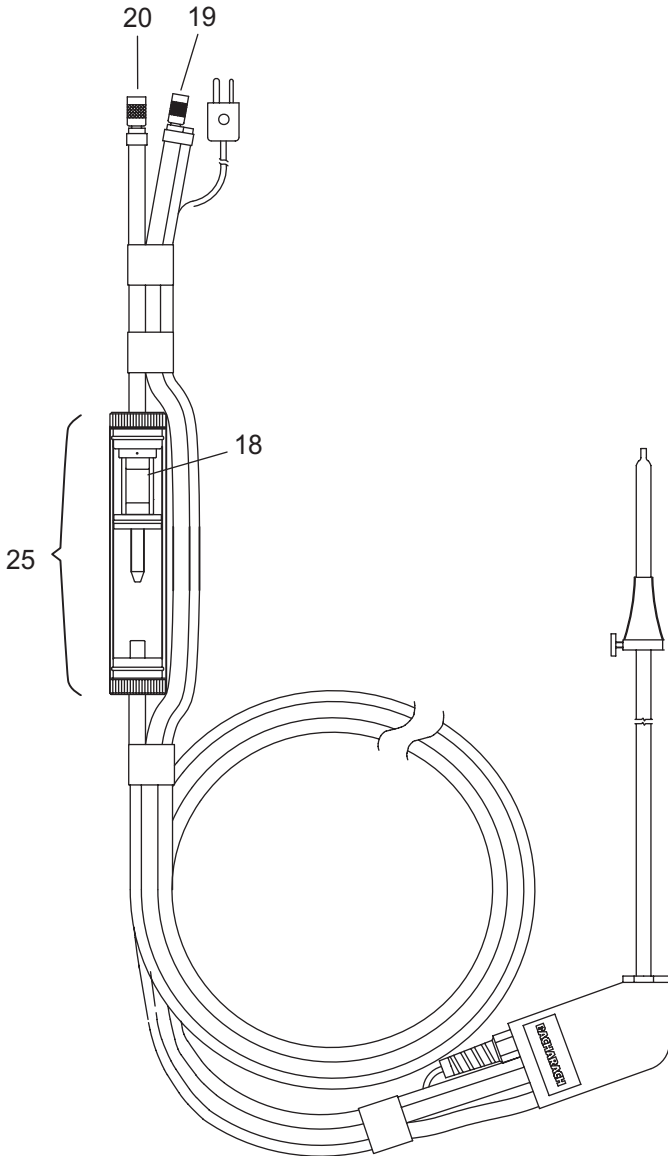

Figure 8-3. Replacement Parts

8.3 Sales/Service Centers

Replacement parts and service can be obtained by contacting one of the following Bacharach Sales/Service Centers:

United States

California

7281 Garden Grove Blvd.,
Suite H
Garden Grove, CA 92841
Phone: 714-895-0050
Fax: 714-895-7950
Email: calservice@bacharach-inc.com

Indiana

8618 Louisiana Place
Merrillville, IN 46410
Phone: 219-736-6178
Fax: 219-736-6269
Email: indservice@bacharach-inc.com

New Jersey

7300 Industrial Park
Rte. 130, Bldg. 22
Pennsauken, NJ 08110
Phone: 856-665-6176
Fax: 856-665-6661
Email: njservice@bacharach-inc.com

Pennsylvania

621 Hunt Valley Circle
New Kensington, PA 15068
Phone: 724-334-5051
Fax: 724-334-5723
Email: help@bacharach-inc.com

Texas

5151 Mitchelldale, B-4
Houston, TX 77092
Phone: 713-683-8141
Fax: 713-683-9437
Email: txservice@bacharach-inc.com

Canada

Bacharach of Canada, Inc.
250 Shields Court Unit #3
Markham, Ontario L3R 9W7 Canada
Phone: 905-470-8985
Fax: 905-470-8963
Email: bachcan@direct.com

México

Bacharach de México
Playa Regatas No. 473 Tercer Piso
Col. Militar Marte
Delegación Iztacalco, 08830
México D.F. México
Phones: +52-555-634-7740
+52-555-634-7741
FAX: +52-555-634-7738
Email: bacharach@prodigy.net.mx

Europe

European Headquarters

Bacharach Instruments
Sovereign House, Queensway
Royal Leamington Spa
Warwickshire CV31 3JR
United Kingdom
Phone: +44-1926-338111
Fax: +44-1926-338110
Email: sales@bacharach-europe.com

Sales / Service Center - Denmark

Bacharach Instruments Int'l
P.O. Box 44
39 Lindegade
DK 6070 Christiansfeld Denmark
Phone: +45-74-563171
Fax: +45-74-563178
Email: mail@bacharach.dk

APPENDIX A

Display Screen Translations

This appendix shows the contents of the various screen displays that are seen while operating the PCA in all ten languages that the analyzer is capable of displaying. The language that is displayed on the analyzer is dependent on the analyzer's model (refer to Table 1-1), and the language selected per Section 4.15.

The languages are arranged in columns side-by-side for comparison and translation purposes.

English (ENG)	German (DEU)	Danish (DAN)	French (FRA)	Spanish (ESP)
Warm Up Screen				
BACHARACH, INC.	BACHARACH, INC.	BACHARACH, INC.	BACHARACH, INC.	BACHARACH, INC.
PCA nn	PCA nn	PCA nn	PCA nn	PCA nn
Warmup nn	KALIBRIEREN nn	OPVARMNING nn	CYCLE D AUTOCALIB nn	CALENTAMIENTO nn

Sensor Status Screen (Errors)

NO ERRORS DETECTED	KALIBRIERUNG OK	INGEN FEJL	PAS D ERREUR DETECTE	NO HAY ERRORES
LOW BATTERY	Batterie leer	LAV BATTERIKAPACITET	BATTERIE FAIBLE	BATTERIA BAJA
O2-SENSOR ERROR	O2-Sensor	O2-SENSOR FEJL	O2-ERREUR DE CAPTEUR	ERROR SENSOR-O2
CO-SENSOR ERROR	CO-Sensor	CO-SENSOR FEJL	ERREUR DE CAPTEUR-CO	ERROR SENSOR-CO
DRAFT-SENSOR ERROR	Feinzug-Sensor	TRAEK-SENSOR FEJL	ERR D CPTR TIRAGE	ERROR SENSOR-TIRO
TA-STACK-SENSOR ERROR	Gas-F_hler	ROEGGASTEMP FEJL	ERREUR D CPTR T-CHMN	ERR SENSOR T-CHIMENE
TA-AIR-SENSOR ERROR	Luft-F_hler	LUFTEMP FEJL	ERREUR D CPTR T-AIR	ERROR SENSOR T-AIRE
NX-SENSOR ERROR	NX-Sensor	NX-SENSOR FEJL	ERREUR DE CAPTEUR	ERROR SENSOR-NX

Sign Off Screen

OFF IN n SEC	Aus in n sec	STOP OM n SEK	TERMNR DANS n SEC	APAG EN n SEGS
--------------	--------------	---------------	-------------------	----------------

RUN/HLD Screen (Abbreviations)

NG	EG	NG	GN	GN
KOK	KG	KOK	GM	GC
LEG	SG	BG	GV	GCD
LPG	FG	FG	LPG	LPG
O#2	H`1	O#2	H#2	P#2
O#6	S`1	O#6	H#6	P#6
PC	KOL	BF	CHR	CAR

Fuel Selection Screen

FUEL	BRENNSTOFF	FUEL	COMBSTBL	COMBUSTB
NATGAS	Erdgas	N-GAS	GAZ NATU	GNATURAL
KOKS	Kok.-Gas	KOKS	GAZ MANU	GCARBON
LEG	Stadtgas	B-GAS	GAZ VIL	GCIUDAD
LPG	Fl.-Gas	F-GAS	PROPANE	LPG
OIL NO.2	Heizuel	LET OLIE	FUEL DOM	PETRO #2
OIL NO.6	Schweroel	TUN OLIE	FUEL LOU	PETRO #6
P-COAL	Kohle	BIOFUEL	CHARBON	CARBON

Draft Screens

DRAFT	FEINZUG	TRAEK	TIRAGE	TIRO
DISCONNECT DRAFT	Saugschlauch	AFMONTER	DEBRANCHER LE TUYAU	DESCONECTE MANGUERA
HOSE	trennen	TRAEKSLANGE	DE TIRAGE	DE ASPIRACION
PRESS ←	← dr_cken	TRYK ←	APPUYER SUR ←	OPRIMA ←
RECONNECT DRAFT	Schlauch	MONTER	REBRANCHER LE TUYAU	RECONNECTE MANGUERA
HOSE	anschließen	TRAEKSLANGE	DE TIRAGE	DE ASPIRACION
DRAFT	Feinzug	TRAEK	TIRAGE	TIRO
HOT SPOT	Gas-Temp	KERNESTR	PNT CHAUD	PTO CLNTE

Polish (POL)	Italian (ITA)	Dutch (NED)	Swedish (SVE)	Finnish (FIN)
BACHARACH, INC. PCA nn NAGRZEWANIE nn	BACHARACH, INC. PCA nn RISCALDAMENTO nn	BACHARACH, INC. PCA nn INITIALISATIE nn	BACHARACH, INC. PCA nn UPPVARMNING nn	BACHARACH, INC. PCA nn MITTARI%MP%%
NIE WYKRYTO BLEDOW SLABY AKUMULATOR BLAD CZUJNIKA-O2 BLAD CZUJNIKA-CO BLAD CZUJNIKA-CIAGU BLAD CZUJNIKA KOMINT BLAD CZUJNIKA POW-T BLAD CZUJNIKA-NX	NO RIVELAZIONE ERROR BATTERIA BASSA ERRORE SENSORE-O2 ERRORE SENSORE-CO ERRORE SENSORE-TIRAG ERRORE SENS-T-CAMINO ERRORE SENSOR-T-ARIA ERRORE SENSORE-NX	GEEN FOUTMELDINGEN VOEDINGSSPANNING ERR: O2-SENSOR ERR: CO-SENSOR ERR: TREK-SENSOR ERR:T-ROOKGAS SENSOR ERR: T-OMG. SENSOR ERR: NX-SENSOR	Inget fel Lag batterikapacitet O2-SENSOR FEL CO-SENSOR FEL Drag-SENSOR FEL Rokgastemp FEL Lufttemp FEL NOX-SENSOR FEL	EI HAVAITTU VIRHEIT% PARISTO LOPPUU VIKA O2-ANTURISSA VIKA CO-ANTURISSA VIKA PAINEANTURISSA SAVUK LT-ANTURIVIKA ILMAN LT-ANTURIVIKA VIKA NX-ANTURISSA
WYTACZ W n SEK	OFF IN n SEC	UIT NA n SEC	Stangs av om n sek	KIINNI n SEK:SSA
GZ GWL GNG LPG O#2 O#6 PC	MET COK CIT GPL O#2 O#6 CAR	NG KOK LEG LPG O#2 O#6 PC	NG KOK SG PG O#2 O#6 BF	MKA KOK KKA PRO K`L R`L BP
PALIWO GAZ ZIEN GAZWEGL GAZNENG PROP PLN OLEJ LEK OLEJ CIE P-COAL	COMBUSTI METANO GAS COKE GASCITTA GPL GASOLIO NAFTA CARBON	BRANDST. AARDGAS KOKS LEG LPG OIL NO.2 OIL NO.6 P-COAL	BRANSLE N-GAS KOKS Stadsgas P-GAS Tunn olja Tjock olja Biofuel	POLTTOAI MAAKAASU HIILIKAA KAUPKAAS PROPAANI KEYVT`LJ RASK`LJY BIOPOAINE
CIAG ODLACZ WAZ DO POMIARU CIAGU NACISNIJ ← PODLACZ PONOWNIE WAZ DO POMIARU CIAGU CIAG OGNISKO	TIRAGGIO DISINSERIRE ASPIRATORE PREMERE ← REINSERIRE ASPIRATORE TIRAGGIO PTO CALDO	TREK-METING ONTKOPPEL LEIDING DRAFT HOSE DRUK ← VERBIND OPNIEUW DE LEIDING (DRAFT HOSE) TREK HOT SPOT	DRAG Tabort drag slang Tryck ← Anslut drag slang Drag Rokgas	VETO IRROITA PAINELETKUN LIITIN PAINA ← LIIT%PAINELETKUN LIITIN PAINE KUUMA KOH

English (ENG)	German (DEU)	Danish (DAN)	French (FRA)	Spanish (ESP)
--------------------------	-------------------------	-------------------------	-------------------------	--------------------------

Saving Memory Screen

SAVING MEMORY LOCATION nn	Speichere Daten in Block nn	LAGRING MEMORY BLOK nn	SAUVEGARDE D MEMOIRE ZONE nn	GUARDANDO UBIBACION DE MEMORIA nn
------------------------------	--------------------------------	---------------------------	---------------------------------	--------------------------------------

Memory Directory Screen

MEMORY DIRECTORY	SPEICHER LISTE	MEMORY BIBLIOTEK	REPertoire MEMRE	DIRECTORIO MEMORI
MEMORY EMPTY	Speicher leer	MEMORY TOM	MEMOIRE VIDE	MEMORIA VACIA
CLEAR MEMORY	Speicher l'schen	SLET MEMORY	EFFACER MEMOIRE	BORRAR MEMORIA

Draft Memory Screen

DRAFT MEM	FEINZUG MEM	TRAEK MEMORY	TIRAGE MEM	TIRO MEM
DRAFT	Feinzug	TRAEK	TIRAGE	TIRO

Clear Memory Screen

CLEAR MEMORY	SPEICHER L'SCHEN	SLET MEMORY	EFFACER MEMOIRE	BORRAR MEMORIA
--------------	------------------	-------------	-----------------	----------------

Memory to PC Screen

MEMORY TO PC	ABSPEICHERN AUF PC	PC HUKOMMELSE	MEMOIROIRE A PC	MEMORIA AL PC
TRANSMIT DATA	Daten ,bertragen	OVERFOER DATA	TRANSM. DONNEES	TRANSMITIR DATOS
CLEAR MEMORY	Speicher l'schen	SLET MEMORY	EFFACER MEMOIRE	BORRAR MEMORIA
TRANSMITTING...	,bertragung...	OVERFOERELSE...	EN TRANSMISSION...	TRANSMITIENDO...

ID Setup Screen

SETUP	KONFIGURIEREN	OPSAETNING	PROGRAMMER	ESTABLECER
ID #n	ID #n	ID #n	ID #n	ID #n

Temperature Setup Screen

SETUP	KONFIGURIEREN	OPSAETNING	PROGRAMMER	ESTABLECER
TEMPERATURE UNIT	Temp.-Einheit	TEMPERATURENHED	UNITE DE TEMPERATURE	UNIDAD DE TEMPERATURA

Draft Setup Screen

SETUP	KONFIGURIEREN	OPSAETNING	PROGRAMMER	ESTABLECER
DRAFT UNIT	Feinzug-Einheit	TRAEKENHED	UNITE DE TIRAGE	UNIDAD DE TIRO
mB/PA/WC	mB/PA/WC	mB/PA/WC	mB/PA/WC	mB/PA/WC

Language Setup Screen

SETUP	KONFIGURIEREN	OPSAETNING	PROGRAMMER	ESTABLECER
LANGUAGE	Sprache w%hlen	SPROGKODE	LANGUE	IDIOMA

Display Mode Setup Screen

SETUP	KONFIGURIEREN	OPSAETNING	PROGRAMMER	ESTABLECER
DISPLAY	Anzeigen	DISPLAY	AFFICHER	VISUALIZAR

Polish (POL)	Italian (ITA)	Dutch (NED)	Swedish (SVE)	Finnish (FIN)
ZACHOWYWANIE MIEJSCE W PAMIECI nn	SALVARE MEMORIA UBICAZIONE nn	OPSLAAN IN GEHEUGEN LOCATIE nn	Sparar minne i block nn	TALLENTAA MUISTI PAIKKAAN nn
KATALOG PAMIECI PAMIEC PUSTA WYCZYSC PAMIEC	INDIRIZZ MEMORIA MEMORIA VUOTA ANNULARE MEMORIA	INHOUD GEHEUGEN GEHEUGEN LEEG GEHEUGEN WISSEN	MINNES BIBLIOTEK Minnet tomt Rensa minnet	MUISTITIEDOSTO MUISTI TYHJfi TYHJENNI MUISTI
CIAG MEM CIAG	TIRAGGIO MEM TIRAGGIO	TREK-METING MEM TREK	DRAG MINNET Drag	VETO MEM PAINE
WYCZYSC PAMIEC	ANNULARE MEMORIA	GEHEUGEN WISSEN	Rensa minnet	TYHJENNI MUISTI
PAMIEC DO PC PRZESLAC DANE WYCZYSC PAMIEC TRANSMISJA...	DA MEMORIA A PC TRASMETTERE DATI ANNULARE MEMORIA TRANSMISSIONE...	GEHEUGEN NAAR PC VERZEND GEGEVENS GEHEUGEN WISSEN VERZENDING...	MINNE TILL PC Overfor data Rensa minnet Overforing...	MUISTI PC:LLE SIIRRF TIEDOT TYHJENNf MUISTI SIIRT%%
USTAW ID #n	PREPARAZIONE ID #n	INSTELLINGEN ID #n	KONFIG ID #n	ASETUKSET TUNNISTE #n
USTAW JEDNOSTKE TEMPERATURY	PREPARAZIONE UNITA DI TEMPER	INSTELLINGEN EENHEID VAN TEMPERATUUR	KONFIG Temperaturenhet	ASETUKSET L%MP*TILAN YKSIKK*
USTAW JEDNOSTKE CIAGU mB/PA/WC	PREPARAZIONE UNITA DI TIRAGGIO mB/PA/WC	INSTELLINGEN EENHEID VAN TREK mB/PA/WC	KONFIG Drag enhet mB/PA/WC	ASETUKSET PAINEEN YKSIKK* mB/PA/WC
USTAW JEZYK	PREPARAZIONE LINGUA	INSTELLINGEN TAAL	KONFIG Sprak	ASETUKSET KIELI
USTAW WYSWIETLIC	PREPARAZIONE VISUALIZZARE	INSTELLINGEN SCHERM	KONFIG DISPLAY	ASETUKSET N%YTT*

English (ENG)	German (DEU)	Danish (DAN)	French (FRA)	Spanish (ESP)
--------------------------	-------------------------	-------------------------	-------------------------	--------------------------

Time/Date Setup Screen

SETUP	KONFIGURIEREN	OPSAETNING	PROGRAMMER	ESTABLECER
TIME	Zeit	TID	HEURE	HORA
DATE	Datum	DATO	DATE	FECHA

Maintenance Password Screen

MAINTENANCE	INSTANDHALTUNG	VELDIGEHOLDELSE	MAINTENANCE	MANTENIMIENTO
PASSWORD	Kenwort	KODEORD	MOT DE PASSE	CONTRASENA

Printer Setup Screen

SETUP PRINTER	KONFIGURIEREN PRINTER	OPSAETNING PRINTER	PROGRAMMER PRINTER	ESTABLECER PRINTER
IR-HP/IR-IRDA/RS232	IR-HP/IR-IRDA/RS232	IR-HP/IR-IRDA/RS232	IR-HP/IR-IRDA/RS232	IR-HP/IR-IRDA/RS232

Maintenance Menu Screen

MAINTENANCE	INSTANDHALTUNG	VELDIGEHOLDELSE	MAINTENANCE	MANTENIMIENTO
CALIBRATION	ABGLEICH	CALIBRATION	CALIBRAGE	CALIBRACION
USER NAME	BENUTZERNAME	BRUGER NAVN	USER NAME	NOMBRE DEL USUARIO

Calibrate Menu Screen

CALIBRATE	ABGLEICHEN	KALIBRER	CALIBRER	CALIBRAR
TA-ZERO	TA-Offst	TA-NUL	TA-ZERO	TA-CERO
TA-SPAN	TA-Gain	TA-SPAN	TA-FRCH	TA-TRAM
TL-ZERO	TL-Offst	TL-NUL	TL-ZERO	TL-CERO
TL-SPAN	TL-Gain	TL-SPAN	TL-FRCH	TL-TRAM
NX	NX	NX	NX	NX
CO	CO	CO	CO	CO
DRAFT	ZUG	TRAEK	TIRAGE	TIRO

Calibrate TA-Zero Screen

CALIBRATE	ABGLEICHEN	KALIBRER	CALIBRER	CALIBRAR
TA-ZERO	TA-OFFSET	TA-NUL	TA-ZERO	TA-CERO
MEASURED	Ist-Wert	MAALT	MESURE	MEDIDA
APPLIED	Soil-Wert	SAND VAERDI	APPLIQUE	APLICADA

Calibrate TA-Span Screen

CALIBRATE	ABGLEICHEN	KALIBRER	CALIBRER	CALIBRAR
TA-SPAN	TA-GAIN	TA-SPAN	FRCHETTE-TA	TA-TRAM
MEASURED	Ist-Wert	MAALT	MESURE	MEDIDA
APPLIED	Soil-Wert	SAND VAERDI	APPLIQUE	APLICADA

Calibrate TL-Zero Screen

CALIBRATE	ABGLEICHEN	KALIBRER	CALIBRER	CALIBRAR
TL-ZERO	TL-OFFSET	TL-NUL	TL-ZERO	TL-CERO
MEASURED	Ist-Wert	MAALT	MESURE	MEDIDA
APPLIED	Soil-Wert	SAND VAERDI	APPLIQUE	APLICADA

Polish (POL)	Italian (ITA)	Dutch (NED)	Swedish (SVE)	Finnish (FIN)
USTAW CZAS DATE	PREPARAZIONE ORA DATA	INSTELLINGEN TIJD DATUM	KONFIG Tid Datum	ASETUKSET AIKA Pivlj
UTRZYMANIE HASTO	MANTENIMENTO PAROLA DORDINE	ONDERHOUD PASWOORD	UNDERHALL PASSWORD	YLLfPITO SALASANA
USTAW PRINTER IR-HP/IR-IRDA/RS232	PREPARAZIONE PRINTER IR-HP/IR-IRDA/RS232	INSTELLINGEN PRINTER IR-HP/IR-IRDA/RS232	KONFIG PRINTER IR-HP/IR-IRDA/RS232	ASETUKSET PRINTER IR-HP/IR-IRDA/RS232
UTRZYMANIE WZORCOWANIE UZYWACZA IMIE	MANTENIMENTO CALIBRAZIONE NOME DELL'UTENTE	ONDERHOUD IJKINGSPROCEDURE GEBRUIKERS ID	UNDERHALL Kalibrering Anvandar namn	YLLfPITO KALIBROINTI KfYTTfJfNIMI
WZORCUJ TA-ZERO TA-ROZP TL-ZERO TL-ROZP NX CO CIAG	CALIBRARE TA-ZERO TA-DIFF TL-ZERO TL-DIFF NX CO TIRAGG	CALIBREER T-RKG-0 T-RKG-1 T-OMG-0 T-OMG-1 NX CO TREK	CALIBRATE TA-ZERO TA-SPAN TL-ZERO TL-SPAN NX CO DRAFT	KALIBROI TS-NOLL TS-YLjR TI-NOLL TI-YLjR NX CO VETO
WZORCUJ TA-ZERO MIERZONA STOSOWANA	CALIBRARE TA-ZERO MISURATO APPLICATO	IJKING T-RKG-0 GEMETEN AANGELEGD	CALIBRATE TA-ZERO MEASURED APPLIED	KALIBROI TS-NOLLA MITATTU SY÷TETTY
WZORCU TA-ROZPIETOS MIERZONA STOSOWANA	CALIBRARE TA-DIFF MISURATO APPLICATO	IJKING T-RKG-1 GEMETEN AANGELEGD	CALIBRATE TA-SPAN MEASURED APPLIED	KALIBROI TS-YLjIRAJA MITATTU SY÷TETTY
WZORCUJ TL-ZERO MIERZONA STOSOWANA	CALIBRARE TL-ZERO MISURATO APPLICATO	IJKING T-OMG-0 GEMETEN AANGELEGD	CALIBRATE TL-ZERO MEASURED APPLIED	KALIBROI TI-NOLLA MITATTU SY÷TETTY

English (ENG)	German (DEU)	Danish (DAN)	French (FRA)	Spanish (ESP)
--------------------------	-------------------------	-------------------------	-------------------------	--------------------------

Calibrate TL-Span Screen

CALIBRATE TL-SPAN	ABGLEICHEN TL-GAIN	KALIBRER TL-SPAN	CALIBRER FRCHETTE-TL	CALIBRAR TL-TRAM
MEASURED	Ist-Wert	MAALT	MESURE	MEDIDA
APPLIED	Soll-Wert	SAND VAERDI	APPLIQUE	APLICADA

Calibrate NX Screen

CALIBRATE NX	ABGLEICHEN NX-GAIN	KALIBRER NX	CALIBRER NX	CALIBRAR NX
MEASURED	Ist-Wert	MAALT	MESURE	MEDIDO
APPLIED	Soll-Wert	SAND VAERDI	APPLIQUE	APLICADO

Calibrate CO Screen

CALIBRATE CO	ABGLEICHEN CO-GAIN	KALIBRER CO	CALIBRER CO	CALIBRAR CO
MEASURED	Ist-Wert	MAALT	MESURE	MEDIDO
APPLIED	Soll-Wert	SAND VAERDI	APPLIQUE	APLICADO

Calibrate CO/H2 Screen

TESTGAS CO/H2	Pr. fgas CO/H2	PROEVGAS CO/H2	TESTERGAZ CO/H2	GAS DE PRUEBA CO/H2
CO VALUE	CO-Anteil	CO VAERDI	VALEUR CO	VALOR DE CO
ENTER CO VALUE	CO-Anteil eingeben	CO VAERDI ENTER	ENTRER VALEUR CO	ENTRAR VALOR DE CO

Calibrate H2 Screen

CALIBRATE H2	ABGLEICHEN H2-GAIN	KALIBRER H2	CALIBRER H2	CALIBRAR H2
MEASURED	Ist-Wert	MAALT	MESURE	MEDIDO
APPLIED	Soll-Wert	SAND VAERDI	APPLIQUE	APLICADO

Calibrate Draft Screen

CALIBRATE DRAFT	ABGLEICHEN FEINZUG	KALIBRER TRAEK	CALIBRER TIRAGE	CALIBRAR TIRO
MEASURED	Ist-Wert	MAALT	MESURE	MEDIDO
APPLIED	Soll-Wert	SAND VAERD	APPLIQUE	APLICADO

User Name Screen

USER NAME	BENUTZERNAME	BRUGER NAVN	USER NAME	NOMBRE DEL USUARIO
LINE n	Zeile n	LINE n	LIGNE n	LINEA n

Miscellaneous

BAD CALIBRATION ENTRY	Kalibrierung nicht möglich	KALIBRERING IKKE MULJGT	ERREUR D'ETALONNAGE	CALIBRACION-INCORRECTA
PURGING CO SENSOR	CO Sp-funktion	SKYLLER CO SENSOR	PURGE CELLULE CO	PURGANDO SENSOR CO

Polish (POL)	Italian (ITA)	Dutch (NED)	Swedish (SVE)	Finnish (FIN)
WZORCUJ TL-ROZPIETOS MIERZONA STOSOWANA	CALIBRARE TL-DIFF MISURATO APPLICATO	IJKING T-OMG-1 GEMETEN AANGELEGD	CALIBRATE TL-SPAN MEASURED APPLIED	KALIBROI TI-YLIBRAJA MITATTU SY÷TETTY
WZORCUJ NX MIERZONE STOSOWANE	CALIBRARE NX MISURATO APPLICATO	IJKING NX-METING GEMETEN AANGELEGD	CALIBRATE NX MEASURED APPLIED	KALIBROI NX MITATTU SY÷TETTY
WZORCUJ CO MIERZONE STOSOWANE	CALIBRARE CO MISURATO APPLICATO	IJKING CO-METING GEMETEN AANGELEGD	CALIBRATE CO MEASURED APPLIED	KALIBROI CO MITATTU SY÷TETTY
TESTUJ GAZ CO/H2 WARTOSC CO WPROWADZ WARTOSC CO	PROVA GAS CO/H2 VALORE CO IMMETTERE VALORE CO	CO/H2-METING CO-GEHALTE GEEF DE WAARDE IN	TESTGAS CO/H2 CO-VALUE ENTER CO-VALUE	TESTIKAASU CO/H2 CO ARVO SY* T% CO ARVO
WZORCUJ H2 MIERZONE STOSOWANE	CALIBRARE H2 MISURATO APPLICATO	IJKING H2-METING GEMETEN AANGELEGD	CALIBRATE H2 MEASURED APPLIED	KALIBROI H2 MITATTU SY÷TETTY
WZORCUJ CIAG MIERZONY STOSOWANY	CALIBRARE TIRAGGIO MISURATO APPLICATO	IJKING TREK-METING GEMETEN AANGELEGD	CALIBRATE DRAFT MEASURED APPLIED	KALIBROI PAINE MITATTU SY* TETTY
UZYWACZA IMIE LINIA n	NOME DELL'UTENTE LINEA n	GEbruikers ID REGEL n	ANVANDAR NAMN LINE n	K%YT%J%NMI RIVI n
ZLA KALIBRACJA PRZEDMUCH SENSORA CO	ERRORE CALIBRAZIONE PURGA SENSORE CO	VALSE INGAVE REINIGING CO SENSOR	BAD CALIBRATION ENTRY RENSAR CO SENSOR	VAARA KALIBROINTIARVO PUHDISTETAAN CO-ANTURI

NOTES:

APPENDIX B – Printout Translations

**English
(ENG)**

**German
(DEU)**

**Danish
(DAN)**

Combustion Test Data

[Line 1: user name]
[Line 2: user name]
[Line 3: user name]

[Line 1: user name]
[Line 2: user name]
[Line 3: user name]

[Line 1: user name]
[Line 2: user name]
[Line 3: user name]

BACHARACH, INC.
PCA 65
SN: xxxxxxx

BACHARACH, INC.
PCA 65
SN: xxxxxxx

BACHARACH, INC.
PCA 65
SN: xxxxxxx

ID1: [optional data]
ID2: [optional data]
ID3: [optional data]

ID1: [optional data]
ID2: [optional data]
ID3: [optional data]

ID1: [optional data]
ID2: [optional data]
ID3: [optional data]

TIME 09:03:27
DATE 28.08.1998

Zeit 09:03:27
Datum 28.08.1998

TID 09:03:27
DATO 28.08.1998

FUEL
NATGAS

BRENNSTOFF
Erdgas

FUEL
N-GAS

STACK-TEMP 190 °C
AMB.-TMP 20.0 °C
O2 4.0 %
CO2 9.5 %
CO 12 ppm
O% COR CO 15 ppm
NX 10 ppm
O% COR NX 12 ppm
qA 8.1 %
LAMBDA 1.24

Abgas-Temp 190 °C
Raum-Temp 20.0 °C
O2 4.0 %
CO2 9.5 %
CO 12 ppm
COunverd. 15 ppm
NX 10 ppm
NXunverd. 12 ppm
qA 8.1 %
Lambda 1.24

ROEGTEMP 190 °C
LUFTTMP 20.0 °C
O2 4.0 %
CO2 9.5 %
CO 12 ppm
CO UFORT 15 ppm
NX 10 ppm
NX UFORT 12 ppm
qA 8.1 %
LAMBDA 1.24

DRAFT -0.12 MB

Feinzug -0.12 MB

TRAEK -0.12 MB

COMMENTS:

Kommentar:

KOMMENTAR:

Draft Only

[Line 1: user name]
[Line 2: user name]
[Line 3: user name]

[Line 1: user name]
[Line 2: user name]
[Line 3: user name]

[Line 1: user name]
[Line 2: user name]
[Line 3: user name]

BACHARACH, INC.
PCA 65
SN: xxxxxxx

BACHARACH, INC.
PCA 65
SN: xxxxxxx

BACHARACH, INC.
PCA 65
SN: xxxxxxx

ID1: [optional data]
ID2: [optional data]
ID3: [optional data]

ID1: [optional data]
ID2: [optional data]
ID3: [optional data]

ID1: [optional data]
ID2: [optional data]
ID3: [optional data]

TIME 13:03:45
DATE 28.08.1998

Zeit 13:03:45
Datum 28.08.1998

TID 13:03:45
DATO 28.08.1998

DRAFT

FEINZUGMESSUNG

TRAEK

DRAFT -0.37 MB

Feinzug -0.37 MB

TRAEK -0.37 MB

COMMENTS:

Kommentar:

KOMMENTAR:

**French
(FRA)**

**Spanish
(ESP)**

**Polish
(POL)**

Combustion Test Data

[Line 1: user name]
[Line 2: user name]
[Line 3: user name]

[Line 1: user name]
[Line 2: user name]
[Line 3: user name]

[Line 1: user name]
[Line 2: user name]
[Line 3: user name]

BACHARACH, INC.
PCA 65
SN: xxxxxxx

BACHARACH, INC.
PCA 65
SN: xxxxxxx

BACHARACH, INC.
PCA 65
SN: xxxxxxx

ID1: [optional data]
ID2: [optional data]
ID3: [optional data]

ID1: [optional data]
ID2: [optional data]
ID3: [optional data]

ID1: [optional data]
ID2: [optional data]
ID3: [optional data]

HEURE 09:03:27
DATE 28.08.1998

HORA 09:03:27
FECHA 28.08.1998

CZAS 09:03:27
DATE 28.08.1998

COMBUSTBL
GAZ NATU

COMBUSTB
GNATURAL

PALIWO
GAZ ZIEN

TEMP-CHMNE 190 °C
TEMP-AMBTE 20.0 °C
O2 .0 %
CO2 9.5 %
CO 12 ppm
O% CO COR 15 ppm
NX 10 ppm
O% NX COR 12 ppm
qA 8.1 %
LAMBDA 1.24

TEMP-CHIME 190 °C
TEMP-AMBTE 20.0 °C
O2 4.0 %
CO2 9.5 %
CO 12 ppm
O% CORR CO 15 ppm
NX 10 ppm
O% CORR NX 12 ppm
qA 8.1 %
LAMBDA 1.24

TEMP-KOMIN 190 °C
TEMP-OTOCZ 20.0 °C
O2 4.0 %
CO2 9.5 %
CO 12 ppm
O% KOR CO 15 ppm
NX 10 ppm
O% KOR NX 12 ppm
qA 8.1 %
LAMBDA 1.24

TIRAGE -0.12 MB

TIRO -0.12 MB

CAIG -0.12 MB

COMMENTRES:

COMENTARIO:

UWAGI:

Draft Only

[Line 1: user name]
[Line 2: user name]
[Line 3: user name]

[Line 1: user name]
[Line 2: user name]
[Line 3: user name]

[Line 1: user name]
[Line 2: user name]
[Line 3: user name]

BACHARACH, INC.
PCA 65
SN: xxxxxxx

BACHARACH, INC.
PCA 65
SN: xxxxxxx

BACHARACH, INC.
PCA 65
SN: xxxxxxx

ID1: [optional data]
ID2: [optional data]
ID3: [optional data]

ID1: [optional data]
ID2: [optional data]
ID3: [optional data]

ID1: [optional data]
ID2: [optional data]
ID3: [optional data]

HEURE 13:03:45
DATE 25.08.96

HORA 13:03:45
FECHA 28.08.1998

CZAS 13:03:45
DATE 28.08.1998

TIRAGE

TIRO

DRAFT

TIRAGE -0.37 MB

TIRO -0.37 MB

CIAG -0.37 MB

COMMENTRES:

COMENTARIO:

UWAGI:

**Italian
(ITA)**

**Dutch
(NED)**

**Swedish
(SVE)**

Combustion Test Data

[Line 1: user name]
[Line 2: user name]
[Line 3: user name]

[Line 1: user name]
[Line 2: user name]
[Line 3: user name]

[Line 1: user name]
[Line 2: user name]
[Line 3: user name]

BACHARACH, INC.
PCA 65
SN: xxxxxxx

BACHARACH, INC.
PCA 65
SN: xxxxxxx

BACHARACH, INC.
PCA 65
SN: xxxxxxx

[ID1: optional data]
[ID2: optional data]
[ID3: optional data]

[ID1: optional data]
[ID2: optional data]
[ID3: optional data]

[ID1: optional data]
[ID2: optional data]
[ID3: optional data]

ORA 09:03:27
DATA 28.08.1998

TIJD 09:03:27
DATUM 28.08.1998

Tid 09:03:27
Datum 28.08.1998

COMBUSTI
METANO

BRANDST.
AARDGAS

BRANSL
N_GAS

CAMINO-TEM 190 °C
AMB-TEMP 20.0 °C
O2 4.0 %
CO2 9.5 %
CO 12 ppm
O% COR CO 15 ppm
NX 10 ppm
O% COR NX 12 ppm
qA 8.1 %
LAMBDA 1.24

ROKGAS-T^o 190 °C
OMG.-T^o 20.0 °C
O2 4.0 %
CO2 9.5 %
CO 12 ppm
O% CO COR 15 ppm
NX 10 ppm
O% COR NX 12 ppm
qA 8.1 %
LAMBDA 1.24

Rokgastemp 190 °C
Luff temp 20.0 °C
O2 4.0 %
CO2 9.5 %
CO 12 ppm
CO outsp. 15 ppm
NX 10 ppm
NX outsp. 12 ppm
qA 8.1 %
LAMBDA 1.24

TIRAGGIO -0.12 MB

TREK -0.12 MB

Drag -0.12 MB

COMMENTI:

OPM.:

Kommentar:

Draft Only

[Line 1: user name]
[Line 2: user name]
[Line 3: user name]

[Line 1: user name]
[Line 2: user name]
[Line 3: user name]

[Line 1: user name]
[Line 2: user name]
[Line 3: user name]

BACHARACH, INC.
PCA 65
SN: xxxxxxx

BACHARACH, INC.
PCA 65
SN: xxxxxxx

BACHARACH, INC.
PCA 65
SN: xxxxxxx

[ID1: optional data]
[ID2: optional data]
[ID3: optional data]

[ID1: optional data]
[ID2: optional data]
[ID3: optional data]

[ID1: optional data]
[ID2: optional data]
[ID3: optional data]

ORA 13:03:45
DATA 28.08.1998

TIJD 13:03:45
DATUM 28.08.1998

Tid 13:03:45
Datum 28.08.1998

TIRAGGIO

TREK-METING

DRAG

TIRAGGIO -0.37 MB

TREK -0.37 MB

Drag -0.37 MB

COMMENTI:

OPM.:

Kommentar:

Finnish (FIN)

Combustion Test Data

[Line 1: user name]
[Line 2: user name]
[Line 3: user name]

BACHARACH, INC.
PCA 65
SN: xxxxxxx

=====
IID1: optional data]
IID2: optional data]
IID3: optional data]

AIKA 09:03:27
PAIVA 28.08.1998

POLTTOAI
MAAKAASU

SKA	LämpöT	190	°C
YMP	LämpöT	20.0	°C
O2		4.0	%
CO2		9.5	%
CO		12	ppm
CO	HAPETON	15	ppm
NX		10	ppm
NX	HAPETON	12	ppm
SAVUPIIPHa		8.1	%
ILMAYLIMaa		1.24	

PAINE -0.12 MB

KOMMENTIT:

Draft Only

[Line 1: user name]
[Line 2: user name]
[Line 3: user name]

BACHARACH, INC.
PCA 65
SN: xxxxxxx

=====
ID1: optional data]
ID2: optional data]
ID3: optional data]

AIKA 13:03:45
Paiva 28.08.1998

VETO

PAINE -0.37 MB

KOMMENTIT:



World Headquarters

621 Hunt Valley Circle, New Kensington, PA 15068

Ph: 724-334-5000 • Fax: 724-334-5001 • Toll Free: 1-800-736-4666

Website: www.bacharach-inc.com • E-mail: help@bacharach-inc.com