

Portable Combustion Analyzer (PCA)

Instruction 0024-9219
Operation & Maintenance

Rev. 10 – May 2010

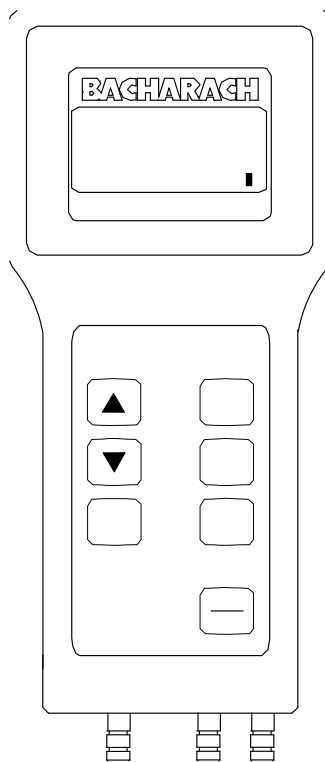

WARRANTY

Bacharach, Inc. warrants to Buyer that at the time of delivery this Product will be free from defects in material and manufacture and will conform substantially to Bacharach Inc.'s applicable specifications. Bacharach's liability and Buyer's remedy under this warranty are limited to the repair or replacement, at Bacharach's option, of this Product or parts thereof returned to Seller at the factory of manufacture and shown to Bacharach Inc.'s reasonable satisfaction to have been defective; provided that written notice of the defect shall have been given by Buyer to Bacharach Inc. within two (2) year after the date of delivery of this Product by Bacharach, Inc. The Oxygen (O₂) Sensor has a limited warranty of one (1) year. Routine service and/or calibration are excluded from this warranty.

Bacharach, Inc. warrants to Buyer that it will convey good title to this Product. Bacharach's liability and Buyer's remedy under this warranty of title are limited to the removal of any title defects or, at the election of Bacharach, to the replacement of this Product or parts thereof that are defective in title.

THE FOREGOING WARRANTIES ARE EXCLUSIVE AND ARE GIVEN AND ACCEPTED IN LIEU OF (I) ANY AND ALL OTHER WARRANTIES, EXPRESS OR IMPLIED, INCLUDING WITHOUT LIMITATION THE IMPLIED WARRANTIES OF MERCHANTABILITY AND FITNESS FOR A PARTICULAR PURPOSE; AND (II) ANY OBLIGATION, LIABILITY, RIGHT, CLAIM OR REMEDY IN CONTRACT OR TORT, WHETHER OR NOT ARISING FROM BACHARACH'S NEGLIGENCE, ACTUAL OR IMPLIED. The remedies of the Buyer shall be limited to those provided herein to the exclusion of any and all other remedies including, without limitation incidental or consequential damages. No agreement varying or extending the foregoing warranties, remedies or this limitation will be binding upon Bacharach, Inc. unless in writing, signed by a duly authorized officer of Bacharach.

**To Register Your Warranty, Visit
www.mybacharach.com**

Notice:

Product improvements and enhancements are continuous, therefore the specifications and information contained in this document may change without notice.

Bacharach, Inc. shall not be liable for errors contained herein or for incidental or consequential damages in connection with the furnishing, performance, or use of this material.

No part of this document may be photocopied, reproduced, or translated to another language without the prior written consent of Bacharach, Inc.

BACHARACH® is a registered trademark of Bacharach, Inc.
All other trademarks are the property of their respective owners.
Copyright © 2010, Bacharach, Inc., all rights reserved.

Contents

1.0 INTRODUCTION	1-1
1.1 The Portable Combustion Analyzer	1-1
1.2 Displayed Data	1-2
1.3 PCA Model Configurations.....	1-3
2.0 TECHNICAL CHARACTERISTICS	2-1
3.0 SETTING UP THE PCA	3-1
3.1 Scope	3-1
3.2 PCA Power	3-1
3.2.1 Checking and Replacing the Batteries	3-1
3.2.2 Using the Optional Power Supply	3-2
3.3 Connecting the Probe	3-2
3.4 Configuring the PCA	3-4
4.0 OPERATION	4-1
4.1 Key Pad Functions.....	4-1
4.2 Sampling Hole Location	4-2
4.3 Performing a Combustion Test	4-3
4.3.1 Analyzer Turn On and Warm Up	4-3
4.3.2 Installing Probe in the Stack	4-4
4.3.3 Starting a Combustion Test	4-5
4.3.4 Ending a Combustion Test	4-5
4.3.5 Turning Off the Analyzer and Purging the CO Sensor ..	4-6
4.4 Differential Pressure Measurement	4-7
4.5 Warm-up Screen	4-8
4.6 Sensor Status Screen	4-9
4.7 Combustion Test Screen	4-10
4.8 Fuel Selection Screen	4-11
4.9 Draft Screens	4-12
4.10 Memory Directory Screen	4-13
4.11 Memory to PC Screen	4-14
4.12 ID Setup Screens	4-17
4.13 Temperature Setup Screen	4-19
4.14 Draft Unit Setup Screen	4-20
4.15 O ₂ Reference Setup Screen	4-21
4.16 Language Setup Screen	4-22
4.17 Display Mode Setup Screen	4-23
4.18 Time / Date Setup Screen	4-24
4.19 Printer / Setup Screen	4-25
4.20 Calibration / Maintenance Password Screen	4-26
4.21 Maintenance Screen	4-27

4.22 User Name Screens 4-28

4.23 Saving Test Data 4-29

4.24 Printing Test Data 4-30

4.25 Clear Memory Screen 4-32

4.26 Resetting the Microprocessor 4-32

5.0 CALIBRATION 5-1

5.1 Sensor Check 5-1

5.2 Calibration Fixtures 5-2

5.3 Calibrate Menu Screen 5-3

5.4 Calibrate TS-Zero 5-4

5.5 Calibrate TS-Span 5-5

5.6 Calibrate TA-Zero 5-6

5.7 Calibrate TA-Span 5-7

5.8 Calibrate NX 5-8

5.9 Calibrate CO 5-9

5.10 Calibrate Draft 5-11

6.0 MAINTENANCE 6-1

6.1 Routine Maintenance 6-1

6.2 Disassembly 6-2

6.3 Cleaning the Probe 6-4

6.4 Water Trap/Filter Assembly Maintenance 6-5

6.5 Replacing the Particulate Filter 6-6

6.6 Replacing the Oxygen Sensor 6-7

6.7 Replacing the Nitric Oxide Sensor 6-8

6.7.1 Replacing the Nitric Oxide Sensor Filter 6-8

6.7.2 Replacing the Nitric Oxide Sensor Bias Battery 6-9

6.8 Replacing the Carbon Monoxide Sensor 6-10

6.8.1 Replacing the Carbon Monoxide Sensor Filter 6-11

6.9 Replacing the Pump Assembly 6-12

7.0 TROUBLESHOOTING 7-1

7.1 Analyzer Repair 7-1

7.2 Error Codes 7-2

7.3 Troubleshooting Guide 7-3

8.0 PARTS & SERVICE 8-1

8.1 Replacement Parts 8-1

8.2 Accessories 8-2

8.3 Service Centers 8-6

APPENDIX A – Display Screen Translations A-1

APPENDIX B – Printout Translations B-1

1.0 INTRODUCTION

1.1 The Portable Combustion Analyzer

The Portable Combustion Analyzer (PCA) (Figure 1-1) is a commercial grade, hand held, combustion efficiency analyzer that is designed for *continuous* (on demand) sampling of light industrial and residential furnaces, appliances, and boilers. The basic instrument is supplied with a probe, instruction manual, batteries, and carrying case.

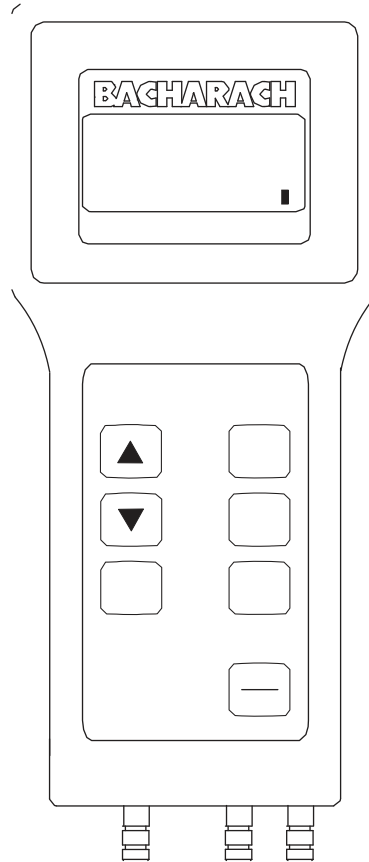

Figure 1-1. PCA

1.2 Displayed Data

The PCA directly measures, displays, and stores the following data:

- Room Temperature in °F or °C (Primary Air/Ambient Temperature)
- Flue Gas Oxygen Content in %
- Flue Gas Temperature in °F or °C
- Flue Gas Carbon Monoxide Content (H₂ Compensated) in ppm
(For analyzers having a Carbon Monoxide sensor)
- Flue Gas Nitric Oxide content in ppm
(For analyzers having a Nitric Oxide sensor)
- Pressure/Draft in Millibars, Pascals, or Inches of Water Column
(For analyzers having a draft sensor)
- Differential Pressure in Millibars, Pascals, or Inches of Water Column
(For analyzers having a draft sensor)

The PCA will compute, display, and store the following data for any of the seven standard fuels:

- Combustion Efficiency in %
- Excess Air in %
- Flue Gas Carbon Dioxide Content in %
- Flue Gas Carbon Monoxide Content referenced to Oxygen in ppm
(For analyzers having a Carbon Monoxide sensor)
- Flue Gas Nitric Oxide Content referenced to Oxygen in ppm
(For analyzers having a Nitric Oxide sensor)

The seven standard types of fuels that can be selected are:

- Natural Gas
- Oil #2
- Oil #4
- Oil #6
- Kerosene
- Propane
- Coal

The PCA continuously monitors flue gas exhaust conditions and updates the above displayed values during a combustion test. If the analyzer is equipped with an optional pressure sensor, then draft measurements can be made simultaneously with the combustion test, or made separately.

The analyzer has the capability of storing data that was collected during a combustion test or draft measurement. The stored data can then at a later date be either viewed on the PCA's display, printed using an optional printer, or downloaded to a computer.

1.3 PCA Model Configurations

TABLE 1-1. PCA SENSOR CONFIGURATIONS

PCA Models				Sensors Installed			
Standard		Advanced		Stack Temp., Air Temp. & O ₂	CO	NX	Draft (ΔP)
PCA Model	Part No. 24-	PCA Model	Part No. 24-				
10	8040	40	8140	X			
15	8041	45	8141	X			X
20	8042	50	8142	X	X		
25	8043	55	8143	X	X		X
30	8044	60	8144	X	X	X	
35	8045	65	8145	X	X	X	X

PCA 10 & 40

These basic instruments have the capability of measuring, displaying, and storing combustion tests. They will also display flue gas Oxygen content, flue gas Carbon Dioxide (CO₂) content, air temperature, flue gas temperature, combustion efficiency, excess air, and the current fuel selected. The 'standard' PCA 10 stores up to 10 combustion tests, while the 'advanced' PCA 40 can store up to 100 tests.

PCA 15 & 45 with Draft

In addition to the features of the basic PCAs described above, these instruments have the added capability of measuring, displaying, and saving draft or differential pressure in either Millibars, Pascals, or Inches-of-Water Column.

PCA 20 & 50 with Carbon Monoxide Measurement

In addition to the features of the basic PCAs described above, these instruments have the added capability of measuring, displaying, and saving Carbon Monoxide (CO) content, as well as calculating a CO level that is referenced to Oxygen. The 'standard' PCA 20 calculates CO referenced to 0% Oxygen, while the 'advanced' PCA 50 calculates CO referenced to a user selected Oxygen level of between 0–15%.

PCA 25 & 55 with Draft and CO Measurement

These instruments combine the features of all the PCAs listed above.

PCA 30 & 60 with CO and Nitric Oxide Measurement

In addition to the features of the basic PCAs with CO measurement, these instruments have the added capability of measuring, displaying, and saving Nitric Oxide (NX) content, as well as calculating a NX level that is referenced to Oxygen. The 'standard' PCA 30 calculates NX referenced to 0% Oxygen, while the 'advanced' PCA 60 calculates NX referenced to a user selected Oxygen level of between 0–15%.

PCA 35 & 65 with Draft, CO & NX

These instruments are capable of measuring, displaying, and saving all measurements as previously described.

Printout Capability

All PCAs have the ability to print the latest test data, or any of the saved tests, to an optional printer via an infrared link.

CO Sensor Purge

On all PCAs that measure CO, if the **ON/OFF** key is pressed while the CO reading is 100 ppm or higher, the analyzer will attempt to purge itself of CO before turning off.

Advanced PCA Model Features

'Advanced' models of the PCA contain the following features that are in addition to the features of their corresponding 'standard' units:

- 100 memory locations
- RS232 output for transferring saved data to a personal computer
- Ability to enter three lines of user-identification information which is printed at the top of each printout
- Ability to enter three lines of customer-identification information which is printed with each test record
- Ability to set the Oxygen reference level from 0 to 15% for CO and NX measurements on analyzers equipped with a CO or NX sensor

2.0 TECHNICAL CHARACTERISTICS

The PCA Directly Measures and Displays:

- Oxygen content in flue gas in the range of 0.1 to 20.9 % O₂
- Flue gas temperature in the range of 0 to 2192 °F (–18 to 1200 °C)
- Primary-air / ambient temperature is in the range of 0 to 999 °F (–18 to 999 °C)

Optional . . .

- Differential Pressure and Draft in the range of ±28" H₂O (±70.0 mb)
- Carbon Monoxide* content in flue gas in the range of 0 to 4000 ppm
- Nitric Oxide* content in flue gas in the range of 0 to 1000 ppm

The PCA Computes and Displays:

When the measured oxygen level is not above 16.0%, and the Stack (Flue Gas) temperature is not above 1832 °F (1000 °C)

- Efficiency in the range of 0.1 to 99.9%
- Excess Air in the range of 1 to 250%
- Carbon Dioxide content in flue gas from 0.1 to a fuel dependent maximum value in percent
- Carbon Monoxide* content referenced to a percentage of Oxygen in the range of 0 to 9,999 ppm on analyzers equipped with a CO sensor.
- Nitric Oxide* content referenced to a percentage of Oxygen in the range of 0 to 9,999 ppm on analyzers equipped with a NX sensor.

Standard Fuels** Available for Combustion Calculations:

- Natural Gas
- Oil #2
- Oil #4
- Oil #6
- Kerosene
- Propane
- Coal

* For the PCA 30, 35, 60, & 65, the display can be set up to show either measured values of Carbon Monoxide and Nitric Oxide (CO & NX), or show the calculated values of these gases (CF & NF) referenced to Oxygen. In either case, all values are listed on the printout of analyzers equipped with a printer.

** Custom fuels available upon request. Contact factory for details.

Normal Operating Conditions:

Temperature:

Analyzer 32 to 104 °F (0 to 40 °C)
 Probe Tip 1472 °F (800 °C) Max.

Humidity:

Analyzer 15 to 90% Relative Humidity, Non-Condensing

Air Pressure:

Analyzer Atmospheric
 Probe 10" H₂O (25 mb) draft max at probe tip

Performance:

Accuracy:

Oxygen* ±0.3% O₂
 Carbon Monoxide ±5% of reading or ±10 ppm, whichever is greater
 between 0 – 2000 ppm, and ±10% of reading
 between 2001 – 4000 ppm.
 Nitric Oxide ±5% of reading or ±5 ppm, whichever is greater
 Flue Gas Temp. ±4 °F between 32 and 255 °F
 (±2 °C between 0 and 124 °C)
 ±6 °F between 256 and 480 °F
 (±3 °C between 125 and 249 °C)
 ±8 °F between 481 and 752 °F
 (±4 °C between 250 and 400 °C)
 Ambient Temp. ±2 °F between 32 and 212 °F
 (±1 °C between 0 and 100 °C)
 Pressure ±2% of reading or ±0.02 inches of Water Column
 (±0.05 mb), whichever is greater

System Flow Rate:

With probe 200 cc/min minimum

Front Panel Controls:

Seven embossed pushbutton switches with tactile feedback (refer to Section 4.3)

Display:

20 character by 4 line alphanumeric LCD panel with a green backlight.

* Accuracy referenced in practical flue gas concentrations
 (mixtures of O₂, CO₂ and N₂)

Power Requirements:

Four AA alkaline batteries. Battery backup for the real-time clock, RAM, and bias voltage for the Nitric Oxide sensor is provided by internal lithium batteries. Optional AC Power Supplies (110 VAC & 230 VAC) are also available.

Operating Time:

A fresh set of batteries will provide at least 8 hours of continuous operation with the pump running and the backlight turned on.

Warm Up Time:

60 seconds.

Printer Interface:

Infrared Communications (refer to Section 4.24).

Materials:

- High impact ABS plastic case
- Polycarbonate window over the display
- Nickel plated, brass quick-connect hose fitting
- Stainless steel probe

Dimensions:

Height: 8.5 in. (215 mm)

Width: 3.8 in. (96 mm) at display (3.0 in. [75 mm] at controls)

Depth: 2 in. (50 mm)

Weight:

With Batteries: Approximately 1.5 lbs (0.7 Kg)

NOTES:

3.0 SETTING UP THE PCA

3.1 Scope

Before using the PCA, you MUST:

- Check the batteries or plug in an Optional Power Supply (Section 3.2)
- Connect the probe to the analyzer (Section 3.3)
- Check the analyzer's configuration (Section 3.4)

3.2 PCA Power

3.2.1 Checking and Replacing the Batteries

A fresh set of batteries is supplied with the PCA. Install the batteries as described below. If a LOW BATTERY message is displayed when the analyzer is turned on, replace the batteries.

1. Remove the battery cover from the back of the PCA (Figure 3-1).
2. Remove (and properly dispose of) any old batteries.
3. Insert a fresh set of four AA alkaline batteries, making sure to install them per the "+" and "-" markings shown in the battery compartment.
4. Replace the battery cover.

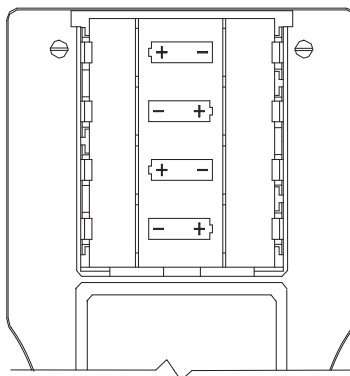

Figure 3-1. Battery Replacement

3.2.2 Using the Optional Power Supply

If an Optional Power Supply is to be used:

1. Connect the output plug of the Optional Power Supply to the analyzer's power supply jack (Figure 3-2).
2. Plug the Optional Power Supply into an appropriate AC wall outlet. The analyzer will now operate and function normally.

3.3 Connecting the Probe

To attach the probe to the analyzer (Figure 3-2):

1. Push the yellow-banded, quick-connect Flue Gas Hose (giving a slight twist) onto the analyzer's GAS sample-inlet fitting.
2. Push the blue-banded, quick-connect Draft Hose (giving a slight twist) onto the analyzer's DRAFT sample-inlet fitting.
3. Push the Flue Gas Thermocouple into the T-STACK jack (connector fits in only one way).

NOTE: *The PCA has a built in room-air thermocouple. Perform Step 4 only if the Optional Room Air/Primary Air Thermocouple is used.*

4. Push the Optional Room Air/Primary Air Thermocouple into the T-AIR jack (connector fits in only one way).

NOTE: *In order for the PCA to correctly calculate combustion efficiency when the burner's primary-air temperature is **not** the same as room temperature, the primary-air temperature should be measured using the optional Primary Air Thermocouple.*

Inspect all the hoses for cracks. If any hose is defective, replace the entire probe assembly. Check that the water trap is empty, and the filter is not dirty or saturated with water.

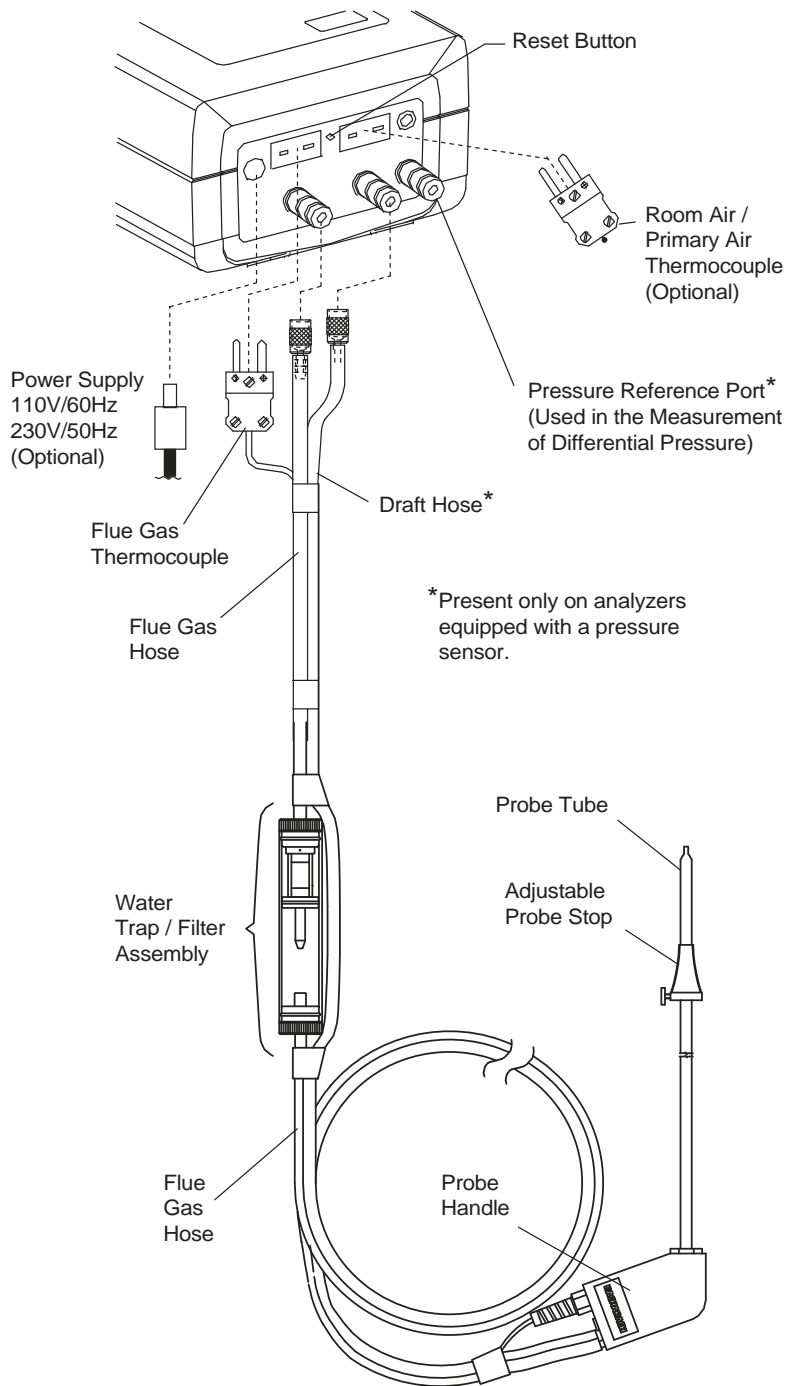

Figure 3-2. Connecting the Probe to the Analyzer

3.4 Configuring the PCA

The PCA is configured at the factory for the parameters shown below. These parameters, however, can be changed by following the instructions in their associated sections.

Function	Parameters	To Change, Refer to . . .
Fuel	Natural Gas	Section 4.8
Temperature	°C	Section 4.13
Draft	WC	Section 4.14
Oxygen Reference	0%	Section 4.15
Language	English	Section 4.16
Display Mode	CO & NX	Section 4.17
Time	HR:MIN:SEC AM/PM	Section 4.18
Date	MM/DD/YY	Section 4.18

4.0 OPERATION

4.1 Key Pad Functions

Descriptions of the key pad functions are given below. Note that most of the front panel key pad buttons perform multiple functions as determined by what screen is being displayed at the time.



Turns the analyzer ON and OFF. Note that there is a 5 second OFF-delay that allows an operator to turn the instrument back ON by pressing the **RUN** key. This feature prevents the accidental loss of test data if the analyzer is turned OFF by mistake.



Moves the cursor [z] in front of a menu item up through the displayed items. This key also increases alphanumeric values in screens requiring a value change.



Moves the cursor [z] in front of a menu item down through the displayed items. This key also decreases alphanumeric values in screens requiring a value change.



Chooses the highlighted item (the item with the cursor [z] in front of it) in all menus and screens. This key also causes the cursor to enter the number field in the Password Screen, and causes the cursor to advance to the next field position in screens requiring multiple alphanumeric entries.



Starts and stops a combustion test when the Combustion Test Screen is displayed. Pressing this key in any other screen almost always returns the instrument to the Combustion Test Screen. However, there are four situations where this key behaves as an enter key: 1) After entering a correct password in the Password Screen, press the **RUN** key to display the first calibration screen. 2) After entering an offset or span value in any of the Calibration Edit Screens, press the **RUN** key to store the new values. 3) After entering a time or date value in the Time/Date Setup Screen, press the **RUN** key to store the new values and return the cursor to the left side of the display. 4) After entering text in either the ID Setup or User Name Screens, press the **RUN** key to store the text.



Advances the display to the next menu screen.



Turns the screen's backlight ON and OFF.

4.2 Sampling Hole Location

The analyzer requires that a ½" diameter sampling hole be made in the furnace stack to accommodate the probe stop on the Probe and Hose Assembly.

Locate the sampling hole downstream from the last heat exchanger, and upstream from any source of dilution, such as a draft diverter (Figure 4-1).

Important! *As the distance between the last heat exchanger and sampling point increases, stack loss will falsely decrease due to heat loss by convection from the flue or stack.*

For residential and light-commercial combustion-equipment applications, the following recommendations are applicable:

- **Oil Gun Burners** – Locate sampling hole at least 12 in. (30 cm) downstream from the furnace breaching, and at least 6 in. (15 cm) upstream from the furnace side of the draft regulator.
- **Gas Burners** – Locate sampling hole at least 6 in. (15 cm) upstream from the furnace side of the draft diverter on gas-converted units. For gas-designed equipment, the probe may be inserted down into the flue through the draft diverter or hood.

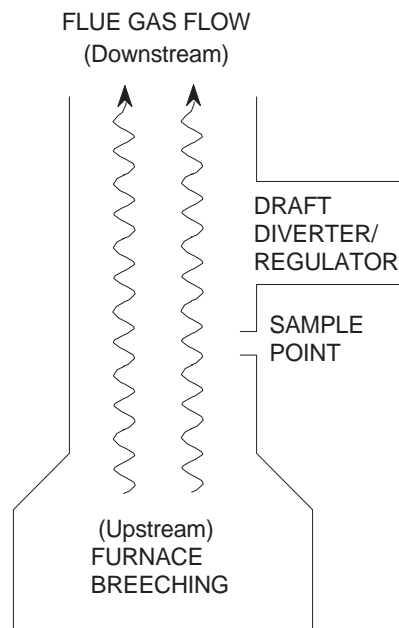

Figure 4-1. Sampling Hole Location

4.3 Performing a Combustion Test

Important! *Large rapid changes in the temperature of the analyzer can affect its accuracy. This is important to know if the analyzer is stored in a cold place (such as an unheated vehicle in the winter) and then taken into a warm furnace area. For the most accurate test results, allow the analyzer to warm up to room temperature before use (about 10 minutes).*

4.3.1 Analyzer Turn On and Warm Up

Important! *Be sure the probe is at room temperature before performing the following steps.*

1. Make sure that the analyzer is properly set up per Section 3.0.
2. Place probe in an area of fresh, ambient air; then press the analyzer's **ON/OFF** key.
3. Wait for the analyzer to countdown through its 60 second warm-up period; then perform one of the following:
 - **If no errors were detected during warm-up**, the Combustion Test Screen will be displayed. Skip Step 4, and go to Section 4.3.2.
 - **If an error was detected during warm-up**, proceed with Step 4.
4. If one or more errors were detected by the analyzer's microprocessor during warm-up, these errors will be displayed at the bottom of the Sensor Status Screen (Section 4.6). Address any problems now per Section 7.2; then repeat this procedure starting with Step 1.

NOTE: *If the error detected is not critical to your test, the instrument can still perform any test not using the function disabled by the error.*

4.3.2 Installing Probe in the Stack

1. After making a sampling hole in the stack (Section 4.2), and turning on the analyzer (Section 4.3.1), screw the probe stop supplied with the Probe and Hose Assembly into the sampling hole (Figure 4-2).
2. Insert the probe through the hole in the probe stop, then position the probe tip inside the stack, near its center. Tighten the thumbscrew on the probe stop to secure the probe.

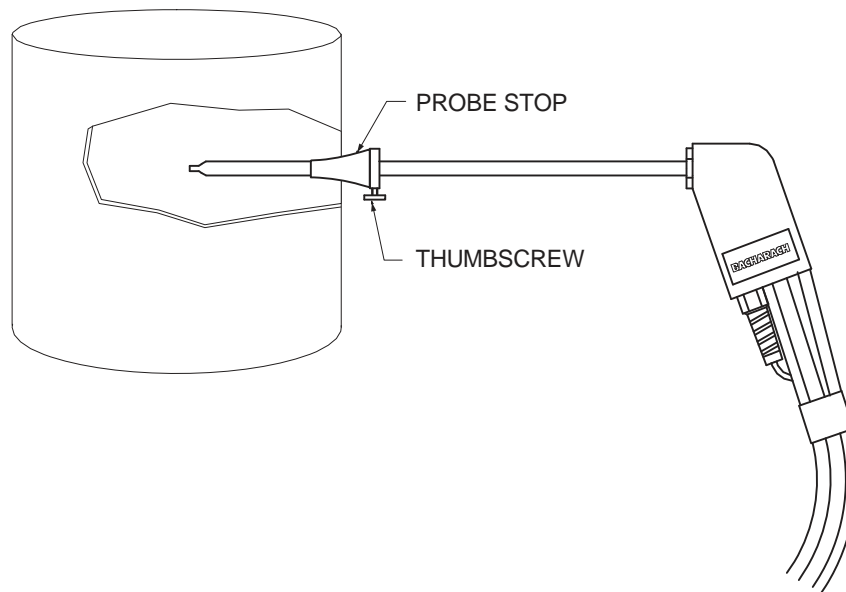

Figure 4-2. Installing the Probe

4.3.3 Starting a Combustion Test

Important! *If the burner's primary-air temperature is not the same as the room temperature, then be sure the Optional Room Air / Primary Air Thermocouple is installed per Section 3.3.*

1. With the Combustion Test Screen (Section 4.7) displayed and the probe installed in the stack, press the **run** key to start a combustion test.
2. Once all sensor readings are displayed: A) Loosen the thumbscrew on the probe stop. B) Move the probe in and out of the stack until the highest stack temperature (TS) reading is obtained. C) Tighten the thumbscrew to prevent further movement of the probe.

Alternately, the highest stack temperature can be located by displaying the Draft Screen (Section 4.9) and adjusting the probe for the highest **HOT SPOT** reading.

Note that locating the highest stack temperature is very important for accurate combustion calculations.

3. You can now begin burner-service procedures. The readings on the analyzer change quickly to show changes in burner performance.

CAUTION

With the Water Trap / Filter Assembly stood up on its Outlet End, do not let water condensate build up beyond the tip of the riser tube. The sensors could be damaged if water would enter the analyzer. Drain the water condensate after every combustion test (refer to Section 6.4).

4. Pressing the **ENTER** key will save the Combustion Test Screen readings while a test is in progress. Moving the cursor (z) in front of the print (P) function using the **↵** key, and then pressing **ENTER** will print the current test information to an optional printer.

4.3.4 Ending a Combustion Test

1. Press the **run** key to end a combustion test. You should hear the pump stop running.

WARNING!

Burn hazard! Allow a hot probe to cool before handling.

CAUTION:

Do not place a hot probe inside the instrument's carrying case. Allow the probe to cool before storage.

2. Loosen the thumbscrew on the probe stop; then remove the probe and probe stop from the stack.
3. If data was saved during the combustion test, you can turn off the analyzer and review or print the stored data at a later time as described in Sections 4.10 and 4.23.

4.3.5 Turning Off the Analyzer and Purging the CO Sensor

Turn off the analyzer by pressing the **ON/OFF** key.

If the **ON/OFF** key is pressed while the CO reading is 100 ppm or higher, the pump will automatically turn on (if not already running) to purge the analyzer of CO.

Important! *The probe must be removed from the stack during the purging process to allow fresh air to be drawn through the analyzer.*

The following message is displayed while the analyzer is being purged.

PURGING CO SENSOR

As soon as the CO level falls below 100 ppm, the pump turns off and the analyzer starts its normal 5 second turn-off sequence.

To abort the purging process and immediately start the analyzer's turn-off sequence, press the **ON/OFF** key again.

NOTE: *Turning the analyzer off initiates a 5-second delay, during which time the unit can be turned on again without any warm-up time. Press the **RUN** key to turn the analyzer back on during this 5-second delay.*

4.4 Differential Pressure Measurement

The difference in pressure (ΔP) between two areas can be measured by using the PCA's two pressure ports and DRAFT Screen. By using Pressure Port 2 (-) as the reference, the pressure applied to Port 1 (+) will be displayed on the DRAFT Screen as the differential pressure between the two ports.

1. Turn on the analyzer by pressing the **ON/OFF** key; wait for the warm-up cycle to complete; then press the **MENU** key until the first DRAFT Screen is displayed (refer to Section 4.9). *If a TA-SENSOR ERROR is displayed, as the result of the probe's thermocouple not being plugged into the analyzer, press the **RUN** key to acknowledge the error before pressing the **MENU** key.*
2. While the first DRAFT Screen is displayed, remove any hoses connected to Pressure Ports 1 and 2; then press the **ENTER** key to zero these ports to atmospheric pressure.
3. Connect two sampling hoses to Pressure Ports 1 and 2 (Figure 4-3). Then place the open end of each hose into the areas being measured.

4. The differential pressure between the two areas is now displayed on the third DRAFT Screen. If the pressure at Port 1 is higher than Port 2, then the pressure difference will be *positive*. But if the pressure at Port #1 is lower, then the pressure difference will be *negative*. The reading shown in this example indicates that the pressure at Port 1 is 0.95" H₂O *lower* than the pressure at Port 2.

DRAFT	
DRAFT	- 0.95 WC
HOT SPOT	---- °C P
	<<S

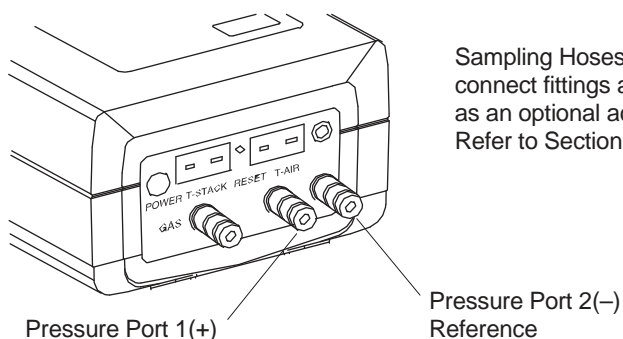

Sampling Hoses with quick-connect fittings are available as an optional accessory. Refer to Section 8.2.

Figure 4-3. Differential Pressure Hose Connections

4.5 Warm-up Screen

BACHARACH, INC.
PCA xx
WARMUP yy







Where: xx = Instrument Model Number
yy = Counts down from 60 seconds

As soon as the **ON/OFF** key is pressed, the instrument's serial number and software version number are displayed for approximately 3 seconds. To continuously display these items, hold down the **ON/OFF** key at start-up. The warmup cycle continues after the **ON/OFF** key is released.

The Warmup Screen is displayed during the analyzer's 60 second warmup cycle, during which time the "Warmup" value (yy) counts down to zero.

After the warmup cycle is complete, (and if the unit is working correctly) the instrument will flash **NO ERRORS DETECTED** and go directly to the Combustion Test Screen (Section 4.7). If there is a problem, however, with one or more of the sensors, the Sensor Status Screen (Section 4.6) is displayed.

Front Panel Key Functions:

-  – No Action
-  – No Action
-  – No Action
-  – No Action
-  – No Action
-  – Toggle Backlight ON/OFF*
-  – Turn analyzer OFF*

* The **LIGHT** button will always turn the backlight on and off, while the **ON/OFF** key will always turn the analyzer on and off. These two keys will not be mentioned in the remainder of this section.

4.6 Sensor Status Screen







Where: xx = Instrument Model Number
z = Sensor(s) in error

If a problem with one or more of the sensors was detected during warmup, the Sensor Status Screen will display an error code for those sensors at the bottom of the screen and wait for operator intervention. Refer to Section 7.2 for a listing and explanation of the error codes.

Note that the analyzer will *not* automatically switch to the Combustion Test Screen if a sensor error was detected. The analyzer, however, can still be used to perform any test that does not depend on the sensor that is in error. Press the **run** key to manually enter the Combustion Test screen to continue using the analyzer.

Front Panel Key Functions:

-  – No Action
-  – No Action
-  – No Action
-  – Go to Combustion Test Screen
-  – No Action

4.7 Combustion Test Screen

PCA models 10 thru 25, 40 thru 55

O2	4.0	CO	12	HLD
C2	9.5	CF	15	NG
TA	68.0	TS	374	P
EF	82.6	EA	21	«S

PCA models 30, 35, 60, & 65

O2	4.0	CO	12	HLD
C2	9.5	NX	10	NG
TA	68.0	TS	374	P
EF	82.6	EA	21	«S

- OR -

This screen shows:





O2	Oxygen content in flue gas (%)
C2	Carbon Dioxide content present in flue gas (%)
TA	Primary/Ambient air temp. (°F)
EF	Combustion efficiency (%)
CO*	Carbon Monoxide content in flue gas (ppm)
CF*	Carbon Monoxide content referenced to a percentage of O ₂ (ppm)
TS	Stack (Flue gas) temperature (°F)
EA	Excess air (%)
NX*	Nitric Oxide content in flue gas (ppm)
NF*	Nitric Oxide content referenced to a percentage of O ₂ (ppm)
HLD/RUN	..	PCA on hold / PCA running test
NG	Fuel code for natural gas (see Section 4.8 for other codes)
P	Print Data
S	Save Data

O2	4.0	CF	15	HLD
C2	9.5	NF	12	NG
TA	68.0	TS	374	P
EF	82.6	EA	21	«S

* For PCA models 30, 35, 60 and 65, you have the option of displaying either CO & NX, or CF & NF. Refer to Section 4.17 for setup instructions.

NOTE: Refer to Section 7.3 if stars (****), dashes (----), or Xs (xxxx) appear in the display.

Front Panel Key Functions:

-  – Move cursor (z) up
-  – Move cursor (z) down
-  – Save or print screen data
-  – Run test / hold test
-  – Go to Fuel Selection Screen

4.8 Fuel Selection Screen

«NATGAS	FUEL
OIL #2	KEROSENE
OIL #4	PROPANE
OIL #6	COAL

This screen is displayed by pressing the **MENU** key from the Combustion Test Screen, and is used to select the fuel being burned.





To select a fuel, first use the **↔** keys to move the cursor (z) in front of the desired fuel, and then press the **ENTER** key.

NOTE: *The fuel selected is saved as the default, and remains in memory after the PCA is turned off.*

The fuel codes as displayed in the Combustion Test Screen:

NG = Natural Gas	KER = Kerosene
O#2= Oil #2	LPG = Propane
O#4= Oil #4	COL = Coal
O#6= Oil #6	

Front Panel Key Functions:

-  – Move cursor (z) up
-  – Move cursor (z) down
-  – Select Fuel
-  – Go to Combustion Test Screen
-  – Go to Draft Screen for PCAs with a pressure sensor, or the Memory Directory Screen for PCAs without a pressure sensor

4.9 Draft Screens

(For PCA Models 15, 25, 35, 45, 55 & 65)

The first Draft Screen is displayed by repeatedly pressing the **MENU** key from the Combustion Test Screen.

```

          DRAFT
DISCONNECT DRAFT
HOSE
PRESS ENTER
  
```

To measure draft, first zero the analyzer's pressure sensor to atmospheric pressure by disconnecting the draft hose from the bottom of the instrument, and then pressing the **ENTER** key. Reconnect the draft hose after the second Draft Screen appears (shown for 3 seconds). The third screen shows the current values of draft and stack temperature as measured by the analyzer.

```

          DRAFT
RECONNECT DRAFT
HOSE
  
```

When using the analyzer to make a differential pressure measurement (Section 4.4), the differential pressure value will appear on the third Draft Screen.





```

          DRAFT
DRAFT      - 0.25 XX
HOT SPOT   190 °C   P
                                     «S
  
```

Where: xx = Unit of measure.
Default is inches of water column (WC). See Optional Draft SETUP Screen (Section 4.14) for other choices.

To save (S) or print (P) the screen data, first use the **←** keys to move the cursor (z) in front of the desired function, and then press the **ENTER** key.

Front Panel Key Functions:

-  – Move cursor (z) up
-  – Move cursor (z) down
-  – Save or Print screen data
-  – Go to Combustion Test Screen
-  – Go to Memory Directory Screen

4.10 Memory Directory Screen

'Standard' PCA Screen

```
MEMORY DIRECTORY
«M8 2/24/01 3:45pm
M9 MEMORY EMPTY
CLEAR MEMORY
```

'Advanced' PCA Screen

```
MEMORY DIRECTORY
«98 2/24/01 3:45pm
99 MEMORY EMPTY
CLEAR MEMORY
```

The Memory Directory Screen is displayed by repeatedly pressing the **MENU** key from the Combustion Test Screen. This screen is used to select a memory location which contains saved data that an operator can review.





NOTE: A 'standard' PCA has 10 memory locations numbered M0 thru M9, while an 'advanced' PCA has 100 memory locations numbered 0 thru 99.

To select a data-memory location, first use the **←** keys to move the cursor (z) in front of the desired memory location; then press the **ENTER** key. The saved data is now displayed in either the Combustion Test Screen or Draft Screen, depending on whether the chosen memory location contains combustion or draft information. To print the saved data, refer to Section 4.23.

After viewing or printing the saved data, use the **←** keys to move the cursor (z) to the exit (E) function; then press **ENTER**. This will redisplay the memory directory.

Selecting the **CLEAR MEMORY** function displays the Clear Memory Screen from where all saved data can be erased (refer to Section 4.24).

Front Panel Key Functions:

-  – Move cursor (z) up
-  – Move cursor (z) down
-  – Display the data saved at the chosen memory location
-  – Go to Combustion Test Screen
-  – Go to Memory To PC Screen for 'Advanced' analyzers, or the Temperature Setup Screen for 'Basic' analyzers

4.11 Memory to PC Screen

(For 'Advanced' PCA Models 40, 45, 50, 55, 60 & 65)

MEMORY TO PC
«TRANSMIT DATA
CLEAR MEMORY

The Memory To PC Screen is displayed by repeatedly pressing the **MENU** key from the Combustion Test Screen. Use this screen to either transmit *all* stored memory locations to a computer, or clear *all* memory locations.

TRANSMIT DATA

Before data can be transmitted to a personal computer, the PCA's RS-232 output must first be connected to an unused computer COM port using serial data cable Part No. 24-1073 (see Figure 4-4). Also, a communications program (i.e., ProcommPlus®, Windows 3.x Terminal, or Windows 9x Hyper Terminal) must be installed, and its communications parameters configured for: **9600 baud, 8 data bits, 1 stop bit, no parity, and no handshaking.**

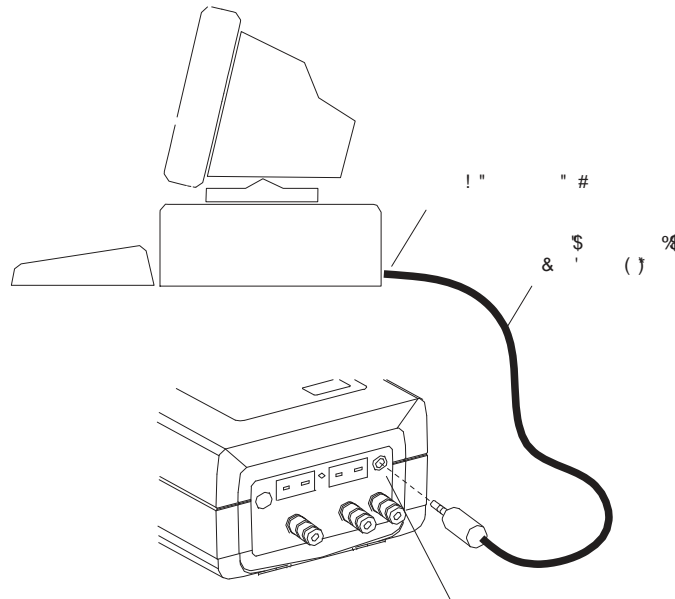

Figure 4-4. Connecting the Serial Data Cable

Data is transmitted to a computer in ASCII *comma-delimited* format, which can be captured as a text file and then opened in most commercially available spreadsheet programs. Note that each data record consists of 20 fields, some of which may be blank for different tests and PCA models as listed in Tables 4-1 & 4-2.

Use the communication software to capture and save the received data as an ASCII text file. Consult the software's documentation for detailed instructions on how to perform this procedure.

To start transmitting data, first use the \leftarrow keys to position the cursor (z) in front of TRANSMIT DATA and then press the ENTER key. Observe that as PCA downloads its data, the word TRANSMITTING... appears on the display.

CLEAR MEMORY

To clear *all* memory locations, first use the \leftarrow keys to position the cursor (z) in front of CLEAR MEMORY and then press the ENTER key. The Clear Memory Screen will then appear from where all saved data can be erased (refer to Section 4.24).

Front Panel Key Functions:





-  – Toggle cursor (z) position
-  – Toggle cursor (z) position
-  – Select function next to cursor
-  – Go to Combustion Test Screen
-  – Go to ID Setup Screen

TABLE 4-1. COMMA-DELIMITED FIELDS

Field	Data Name or Value	Label in Column Headings
1	Instrument serial number	SN
2	ID line 1 (up to 16 characters)	ID1
3	ID line 2 (up to 16 characters)	ID2
4	ID line 3 (up to 16 characters)	ID3
5	Time of test (hh:mm:ss)	TIME
6	Date of test (dd.mm.yyyy)	DATE
7 ¹	Name of fuel (up to 16 characters)	FUEL
8 ¹	Flue gas temperature	TS
9 ¹	Air temperature	TA
10 ¹	Temperature unit of measure (°F or °C)	C/F
11 ¹	O ₂ concentration in %	O2
12 ¹	CO ₂ concentration in %	C2
13 ^{1,2}	CO concentration in ppm	CO
14 ^{1,2}	CO referenced to nn% O ₂ in ppm	CF
15 ^{1,3}	NO concentration in ppm	NX
16 ^{1,3}	NO referenced to nn% O ₂ in ppm	NF
17 ^{1,2}	O ₂ Reference used in fields 14 and 16	O2R
18 ¹	Combustion efficiency in %	EF
19 ¹	Excess air in %	EA
20	Draft measurement	DR
21	Draft unit of measure	MB/PA/WC

¹ Empty data field for draft tests
² Empty data field for PCA Models 10, 15, 40 and 45
³ Empty data field for PCA Models 10, 15, 20, 25, 40, 45, 50, and 55

TABLE 4-2. TYPICAL SPREADSHEET FOR A PCA 65

SN	ID1	ID2	ID3	TIME	DATE	FUEL	TS	TA	C/F	O2
AX1020	ID LINE 1	ID LINE 2	ID LINE 3	9:03:27 PM	2/24/1999	NATGAS	374	68	F	4
AX1020	ID LINE 1	ID LINE 2	ID LINE 3	9:10:35 PM	2/24/1999					

C2	CO	CF	NX	NF	O2R	EF	EA	DR	MB/PA/WC
9.5	12	13	10	11	3	82.2	21	-0.25	WC
								-0.25	WC

Line 1: Column Headings
 Line 2: Typical Combustion Readings
 Line 3: Typical Draft Readings

4.12 ID Setup Screens





(For 'Advanced' PCA Models 40, 45, 50, 55, 60 & 65)



This initial ID Setup Screen is displayed by repeatedly pressing the **MENU** key from the Combustion Test Screen. Use this screen to edit three lines of customer information (e.g., the customer's name, location, and burner reference number).

Each ID line can be up to 16 alphanumeric characters in length. All three lines will appear at the top of each test record for the purpose of identifying individual tests.

Front Panel Key Functions for the Initial ID SETUP Screen:

-  – Move cursor (z) upward
-  – Move cursor (z) downward
-  – Select ID Number that is next to the cursor for editing
-  – Go to Combustion Test Screen
-  – Go to Temperature Setup Screen

To enter a line of text, first use the **st** keys to position the cursor (z) in front of the desired ID line; then press **ENTER**. The selected ID Line Number Screen will then appear.



Now press the **st** keys until the desired letter or number is displayed. Available characters include:

“(space)ABCDEFGHIJKLMNOPQRSTUVWXYZ0123456789”

Press **ENTER** to save the selected character and advance to the next position. If you make a mistake, press **ENTER** until the cursor is over the incorrect character and make your correction by again using the **set** keys. After all the desired characters have been selected, press the **RUN** key to save the text line and return to the initial ID SETUP Screen.

NOTE: *The entered ID information will be saved with all future test records until it is modified or deleted.*

Front Panel Key Functions for the Individual ID SETUP Screens:



– Increment character



– Decrement character



– Select the displayed character and advance to the next character position



– Save the text line and return to the initial ID SETUP Screen



– Abort any changes to the text line and return to the initial ID SETUP Screen





4.13 Temperature Setup Screen



The Temperature Setup Screen is displayed by repeatedly pressing the **MENU** key from the Combustion Test Screen. Use this screen to setup the analyzer to display temperature in either °C or °F.

To select the temperature unit-of-measure, first use the **↔** keys to move the cursor (z) in front of °C or °F, and then press the **ENTER** key.

Front Panel Key Functions:

-  – Move cursor (z) up
-  – Move cursor (z) down
-  – Select unit-of-measure next to cursor
-  – Go to Combustion Test Screen
-  – Go to Draft Unit Setup Screen for PCAs with a pressure sensor, or the O₂ Reference Screen for 'Advanced' PCAs that have an NX and/or CO sensor, or the Language Setup Screen for all other PCAs

4.14 Draft Unit Setup Screen



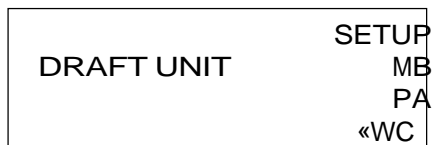

(For PCA Models 15, 25, 35, 45, 55 & 65)



The Draft Unit Setup Screen is displayed by repeatedly pressing the **MENU** key from the Combustion Test Screen. Use this screen to setup the analyzer to display draft in either millibars (MB), Pascals (PA), or inches-of-water column (WC).

To select the draft unit-of-measure, first use the **↔** keys to move the cursor (z) in front of MB, PA or WC, and then press the **ENTER** key.

Front Panel Key Functions:

-  – Move cursor (z) up
-  – Move cursor (z) down
-  – Select unit-of-measure next to cursor
-  – Go to Combustion Test Screen
-  – Go to O₂ Reference Setup Screen for 'Advanced' PCAs that have an NX and/or CO sensor, or the Language Setup Screen for all other PCAs

4.15 O₂ Reference Setup Screen

(For 'Advanced' PCA Models 50, 55, 60 and 65)

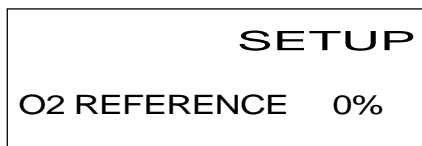





The O₂ Reference SETUP Screen is displayed by repeatedly pressing the **MENU** key from the Combustion Test Screen. Use this screen to select the O₂ reference level that the analyzer will use to calculate the CO and NX gas levels as referenced to Oxygen.

NOTE: *The O₂ reference level for 'standard' PCA models 20, 25, 30 and 35 is preset to 0% O₂ and cannot be changed.*

For PCAs with just a CO sensor, the Combustion Test Screen can show both the measured level of CO, and its calculated level referenced to Oxygen displayed as CF. For PCAs with both CO and NX sensors, the Combustion Test Screen can only show either the measured levels of CO and NX, or their calculated levels referenced to Oxygen displayed as CF and NF, respectively. Refer to Section 4.17 for set up instructions.

To select the analyzer's Oxygen reference level, press the **←** keys until the desired level is displayed, and then press the **ENTER** key.

Front Panel Key Functions:

-  – Increment O₂ Reference (15% max)
-  – Decrement O₂ Reference (0% min)
-  – Select O₂ Reference
-  – Go to Combustion Test Screen
-  – Go to Language Setup Screen





4.16 Language Setup Screen



The Language Setup Screen is displayed by repeatedly pressing the **MENU** key from the Combustion Test Screen. Use this screen to select the language displayed on the analyzer. The languages available for selection include English (ENG), Spanish (ESP), and French (FRA).

To select a language, first use the **↔** keys to move the cursor (z) in front of ENG, ESP or FRA, and then press the **ENTER** key.

Front Panel Key Functions:

-  – Move cursor (z) up
-  – Move cursor (z) down
-  – Select Language next to cursor
-  – Go to Combustion Test Screen
-  – Go to Display Mode Setup Screen for PCAs that have both a CO and NX sensor, or the Time/Date Setup Screen for all other PCAs

4.17 Display Mode Setup Screen

(For PCA Models 30, 35, 60 & 65)







The Display Setup Screen is displayed by repeatedly pressing the **MENU** key from the Combustion Test Screen. Use this screen to select whether the Combustion Test Screen will display the measured values of Carbon Monoxide and Nitric Oxide (CO and NX), or the calculated values of these gases (CF and NF) referenced to Oxygen.

NOTE: *The levels of CO, NX, CF and NF are always included on the printout and in the downloaded data of each combustion test, regardless of what is being displayed on the Combustion Test Screen.*

To setup the display, first use the **set** keys to move the cursor (z) in front of either **CONX** (measured values), or **CF NF** (calculated values), and then press the **ENTER** key.

Front Panel Key Functions:

-  – Move cursor (z) up
-  – Move cursor (z) down
-  – Select Display Mode next to cursor
-  – Go to Combustion Test Screen
-  – Go to Time/Date Setup Screen

4.18 Time / Date Setup Screen

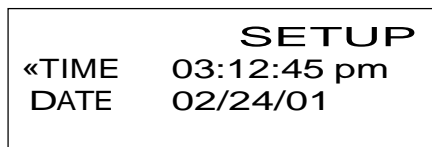

The Time/Date Setup Screen is displayed by repeatedly pressing the **MENU** key from the Combustion Test Screen. Use this screen to enter the current time and date as follows:

Use the **st** keys to move the cursor (z) in front of the **TIME** or **DATE** field to be changed, and then press the **ENTER** key to move the cursor inside the selected field. Again press the **ENTER** key to select the field position to change; after which, use the **st** keys to increase or decrease the value of that field. Continue using the **ENTER** and **st** keys until all values within the chosen field are correct; then press **RUN** to save all field values and return the cursor to the left side of the screen.

Front Panel Key Functions:



– Move cursor (z) up, or Increase value in selected field position



– Move cursor (z) down, or Decrease value in selected field position



– Select Time or Date field to be changed as selected by the cursor's position, and then use to move the cursor through the field positions



– Go to the Combustion Test Screen, or save the time and date values and return cursor to left side of screen



– Go to Setup / Printer Screen, or return cursor to left side of screen

4.19 Printer Setup Screen



The Printer Setup Screen is displayed by repeatedly pressing the **MENU** key from the Combustion Test Screen. Use this screen to choose the type of connection and printer being used.

- IR-HP:** Infrared connection to a printer manufactured by Hewlett Packard, which uses their proprietary infrared communications protocol
- IR-IRDA:** Infrared connection to a printer that uses a standard IrDA protocol
- RS232:** Cable connection between the PCA and any serial printer capable of 9600 baud operation

Use the **↔** keys to move the cursor (z) in front of the desired connection and printer, and then press the **ENTER** key to make the selection and return to the Combustion Test Screen.

Front Panel Key Functions:



– Move cursor (z) up



– Move cursor (z) down



– Select connection and printer next to cursor



– Go to Combustion Test Screen



– Go to Calibration / Maintenance Password Screen

4.20 Calibration / Maintenance Password Screen

PCA models 10 thru 35

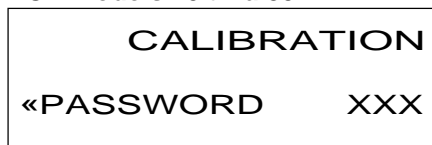

PCA models 40 thru 65

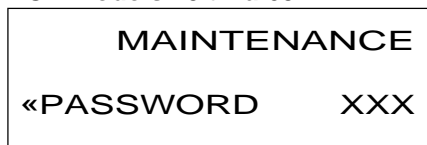





Where: xxx = Password number

The Calibration / Maintenance Password Screen is displayed by repeatedly pressing the **MENU** key from the Combustion Test Screen. From here a three-digit password must be entered to access the PCA 10 thru 35's Calibration Menu Screen (Section 5.3), or a PCA 40 thru 65's Maintenance Screen (Section 4.21). The password is provided on the *Portable Combustion Analyzer Calibration Password* card that was supplied with the analyzer.

To enter the password, first press the **ENTER** key to move the cursor (z) into the first number field; next press the **←** keys until the first digit of the password is displayed; then press **ENTER** to advance to the second number field. In a similar manner, enter the next two password digits. Then press the **RUN** key after the correct password is entered to display either the Calibration Menu Screen or the Maintenance Screen.

Front Panel Key Functions:

-  – No action, or increase value in password number field
-  – No action, or decrease value in password number field
-  – Move cursor (z) to next position in password number field
-  – Go to Combustion Test Screen (if cursor is on left side of screen), or go to either the Calibration Menu or Maintenance Screen (if the proper password was entered), or return cursor to left side of screen (if the wrong password was entered)
-  – Go to Combustion Test Screen (if cursor is on left side of screen), or return cursor to left side of screen (if cursor is inside the password number field)

4.21 Maintenance Screen

(For PCA Models 40, 45, 50, 55, 60 & 65)





MAINTENANCE
«CALIBRATION
USER NAME

The Maintenance Screen is displayed after entering the correct password in the Maintenance Password Screen. Use this screen to either enter the analyzer's Calibration Menu Screen or User Name Screen.

To enter the Calibration Menu Screen (Section 5.3), use the **↔** keys to position the cursor (z) in front of CALIBRATION, and then press the **ENTER** key.

To enter the User Name Screen (Section 4.22), use the **↔** keys to position the cursor (z) in front of USER NAME, and then press the **ENTER** key.

Front Panel Key Functions:

-  – Toggle cursor (z) position
-  – Toggle cursor (z) position
-  – Select function next to cursor
-  – Go to Combustion Test Screen
-  – No action

4.22 User Name Screens





(For PCA Models 40, 45, 50, 55, 60 & 65)

USER NAME
«LINE 1
LINE 2
LINE 3

This initial User Name Screen is displayed after selecting USER NAME from the Maintenance Screen. Use this screen to either enter or edit three lines of user-name information.

Each user-name line can be up to 20 alphanumeric characters in length. All three lines will appear at the top of each printout for the purpose of identifying the user or owner of the instrument (i.e., your company's name and address).

Front Panel Key Functions for Initial User Name Screen:

-  – Move cursor (z) upward
-  – Move cursor (z) downward
-  – Select Line Number next to the cursor for editing
-  – Go to Combustion Test Screen
-  – Return to Maintenance Screen

To enter text, first use the **↑** keys to position the cursor (z) in front of the desired line number; then press **ENTER**. The selected User Name Line Number Screen will then appear.

USER NAME
LINE 1
«





Now press the **←** keys until the desired letter or number is displayed. Available characters include:

“(space)ABCDEFGHIJKLMNOPQRSTUVWXYZ0123456789”

Press **ENTER** to save the selected character and advance to the next position. If you make a mistake, press **ENTER** until the cursor is over the wrong character and make your correction by again using the **←** keys.

After all the desired characters have been selected, press **RUN** to save the text line and return to the initial User Name Screen.

Front Panel Key Functions for Individual User Name Screens:

-  – Increment character
-  – Decrement character
-  – Select the displayed character and advance to the next character position
-  – Save the text line and return to the initial User Name Screen
-  – Abort any changes to the text line and return to the initial User Name Screen

4.23 Saving Test Data

O2	4.0	CO	12	HLD
C2	9.5	NX	15	NG
TA	68.0	TS	374	P
EF	82.6	EA	21	«S

				DRAFT
DRAFT		- 0.25	WC	
HOT SPOT		374 °F		P
				«S

To save the data displayed in either the Combustion Test or Draft Screen, first use the **←** keys to move the cursor (z) in front of the save (S) function and then press the **ENTER** key. The displayed data will be saved in memory, and can be recalled at a later time for viewing from the Memory Directory Screen (Section 4.10).

NOTE: *Data will be automatically stored in the next free memory location. After all memory locations are filled, any additional data that is saved will start overwriting data starting at the first memory location.*

4.24 Printing Test Data

O2	4.0	CO	12	HLD
C2	9.5	NX	15	NG
TA	68.0	TS	374	«P
EF	82.6	EA	21	S

			DRAFT
DRAFT	- 0.25	WC	
HOT SPOT	374 °F	«P	
			S

Before printing, ensure that the correct connection and printer has been selected per Section 4.19.

The Print function is available in either the Combustion Test Screen or the Draft Screen.

NOTE: *The data which is stored in memory can also be printed. First go to the Memory Directory Screen (Section 4.10) and display the data to be printed; then print the data as described below.*

When using an infrared printer:

1. Place analyzer in-line with the printer's IR input (see Figure 4-5).
2. Use the **st** keys to move the cursor (z) in front of the print (P) function.
3. Press the **ENTER** key to start printing.

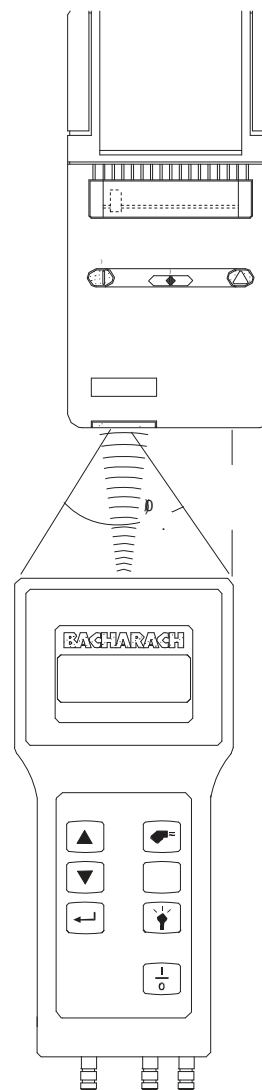

Figure 4-5. Aligning the Printer's IR input to the Analyzer

When using a serial printer:

1. First connect the analyzer to the printer using the optional RS-232 cable (see Figure 4-6).
2. Set the printer's communication parameters to 9600 baud, 8 data bits, 1 stop bit, no parity, and no handshaking.
3. Use the \leftarrow keys to move the cursor (z) in front of the print (P) function.
4. Press the ENTER key to start printing.

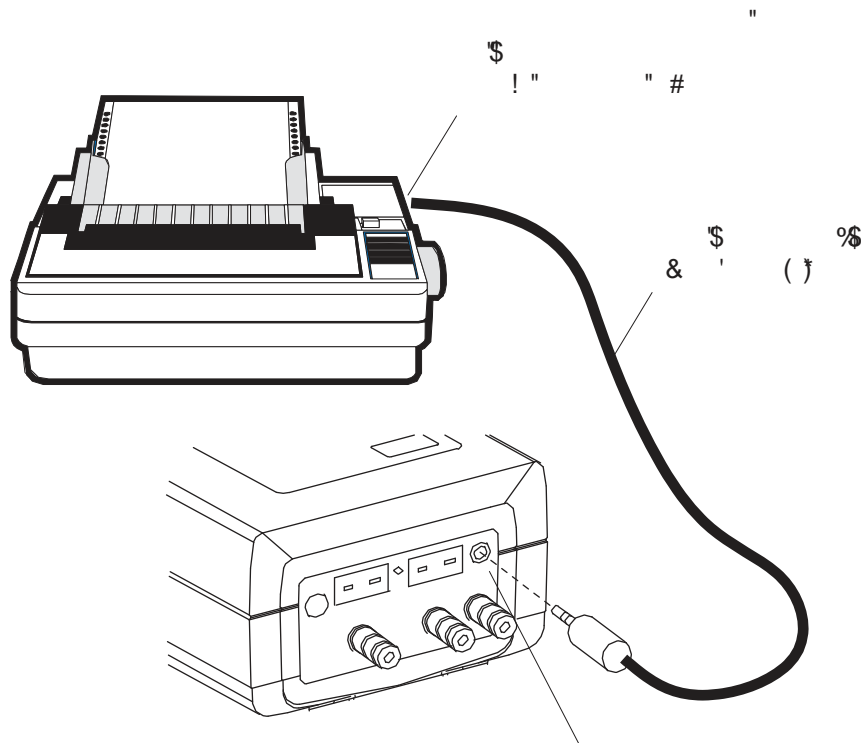
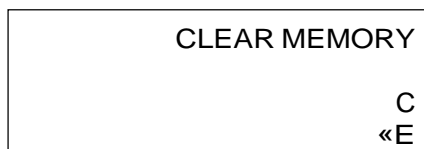

Figure 4-6. Connecting a Serial Printer to the Analyzer

4.25 Clear Memory Screen



The Clear Memory Screen is accessed from either the Memory Directory Screen (Section 4.10) or the Memory to PC Screen (Section 4.11).

To clear **all** memory locations, use the **←** keys to move the cursor (z) in front of the clear (C) function, and then press the **ENTER** key.

To return to the previous screen without clearing memory, place the cursor (z) in front of the exit (E) function and press **ENTER**.

4.26 Resetting the Microprocessor

If the analyzer “locks-up” and cannot be turned OFF, reset the microprocessor by pressing the **RESET** button (Figure 4-7). The button can be activated using the end of a paper clip.

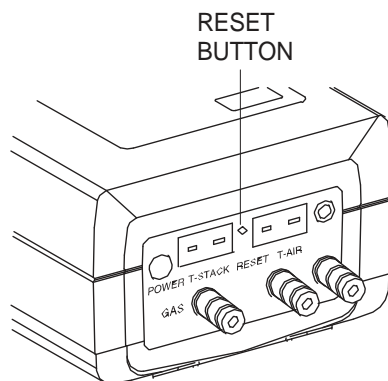

Figure 4-7. Reset Button

5.0 CALIBRATION

NOTE: *Bacharach recommends that the PCA be calibrated by your nearest Bacharach Service Center. Calibration, however, can be performed in the field if your facility has the necessary equipment and qualified personnel to perform the procedures described in the sections that follow.*

Important! *To prevent the loss of data during calibration, perform the following procedures using fresh batteries, or using an optional Power Supply (see Section 3.2).*

Do not make calibration adjustments to the instrument without applying calibration span gas. Making adjustments without applying span gas could render the instrument inaccurate or unusable until re-calibration is performed correctly with span gas.

5.1 Sensor Check

Important! *Before turning on the analyzer or performing any of the calibration procedures, ensure that the analyzer will be sampling fresh air, and that the probe is at room temperature.*

When the analyzer is first turned on and allowed to cycle through its 60 second warmup period, and while sampling fresh air, the sensors are checked (read) and calibrated (set) to the following ambient conditions:

- Oxygen sensor is spanned to 20.9%
- Carbon Monoxide sensor (if installed) is zeroed
- Nitric Oxide sensor (if installed) is zeroed
- Pressure sensor (if installed) is zeroed

If a sensor problem is detected by the analyzer's microprocessor during the warm-up cycle, an error message will be displayed at the bottom of the LCD display. Refer to Section 7.2 for a listing of the error codes.

5.2 Calibration Fixtures

A gas and a draft fixture will be required to perform the various calibration procedures described in this manual.

Material Required:

- Calibration Kit (Refer to Section 8.2)
- Calibration Gas Cylinder (Refer to Section 8.2)
- Bellows
- Micromanometer

Procedure:

Assemble the appropriate fixture shown in Figure 5-1 as required by the calibration procedure being performed.

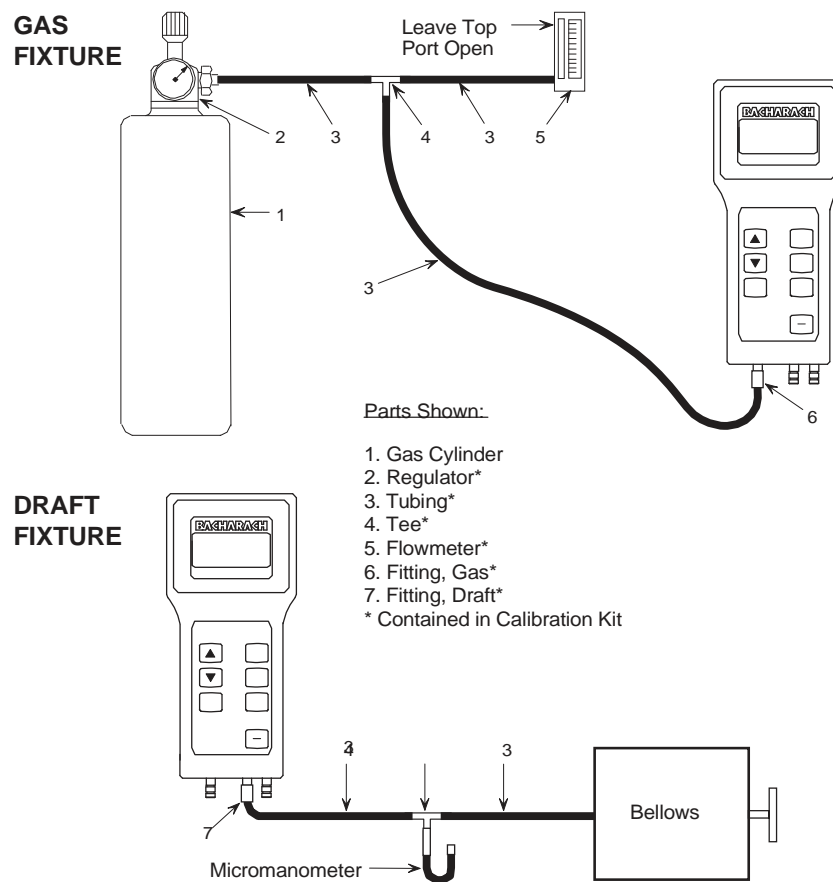

Figure 5-1. Calibration Fixtures

5.3 Calibrate Menu Screen

«TS-ZERO	CALIBRATE
TS-SPAN	NX
TA-ZERO	CO
TA-SPAN	DRAFT





The Calibrate Menu Screen is displayed after entering either the correct password in the Calibration Password Screen for 'standard' PCAs, or the Maintenance Password Screen and selecting CALIBRATION from the Maintenance Screen for 'advanced' PCAs (refer to Sections 4.19 and 4.20). Use this screen to select the sensor to be calibrated.

Press the **set** keys until the cursor (z) is in front of the desired function, and then press the **ENTER** key.

NOTE: *TS is the stack temperature sensor, while TA is the optional Room Air/Primary Air temperature sensor.*

NOTE: *If an optional sensor is not installed, the user will not be able to enter the corresponding calibration screen.*

Front Panel Key Functions:

-  – Move cursor (z) up
-  – Move cursor (z) down
-  – Select sensor to be calibrated next to cursor
-  – Go to Combustion Test Screen
-  – Return to previous screen

5.4 Calibrate TS-Zero

Material Required:

- Thermocouple Simulator (K-type) Range: 0 to 600 °F
Accuracy: ±0.5 °F

Procedure:

1. With the analyzer turned off, first plug the simulator's K-type connector into the T-STACK jack (Figure 3-2); then turn on the analyzer and wait for its warm-up cycle to complete.
2. Enter the Calibration Menu Screen per Section 5.3; then choose TS-ZERO to zero the analyzer's stack temperature channel.
3. Adjust the simulator to 32 °F (0 °C).*
4. Wait until the MEASURED reading on the screen stabilizes. Then use the **set** and **ENTER** keys to enter an APPLIED value that equals 32 °F (0 °C).

Typical Calibrate TS-Zero Screen During Calibration Procedure:

CALIBRATE TS-ZERO	
MEASURED	37.0°F
APPLIED	0032.0°F

4. Press the **run** key to calibrate the analyzer's MEASURED value to that of the APPLIED value. At this time the Calibrate Menu Screen is redisplayed.

* The TS-Zero calibration range is 32 – 41 °F (0 – 5 °C). Any attempt to calibrate outside this range will cause the analyzer to display the message BAD CALIBRATION ENTRY.

5.5 Calibrate TS-Span

Material Required:

- Thermocouple Simulator (K-type) Range: 0 to 600 °F
Accuracy: ± 0.5 °F

Procedure:

1. With the analyzer turned off, first plug the simulator's K-type connector into the T-STACK jack (Figure 3-2); then turn on the analyzer and wait for its warm-up cycle to complete.
2. Enter the Calibration Menu Screen per Section 5.3; then choose TS-SPAN to span the analyzer's stack temperature channel.
3. Set the simulator to 575 °F (302 °C).*
4. Wait until the MEASURED reading on the screen stabilizes. Then use the **set** and **ENTER** keys to enter an APPLIED value that equals 575 °F (302 °C).

Typical Calibrate TS-Span Screen During Calibration Procedure:

CALIBRATE TS-SPAN	
MEASURED	595.0°F
APPLIED	0575.0°F

4. Press the **run** key to calibrate the analyzer's MEASURED value to that of the APPLIED value. At this time the Calibrate Menu Screen is redisplayed.

* The TS-Span calibration range is 518 – 626 °F (270 – 330 °C). Any attempt to calibrate outside this range will cause the analyzer to display the message BAD CALIBRATION ENTRY.

5.6 Calibrate TA-Zero

Material Required:

- Thermocouple Simulator (K-type) Range: 0 to 600 °F
Accuracy: ± 0.5 °F

Procedure:

1. With the analyzer turned off, first plug the simulator's K-type connector into the T-AIR jack (Figure 3-2); then turn on the analyzer and wait for its warm-up cycle to complete.
2. Enter the Calibration Menu Screen per Section 5.3; then choose TA-ZERO to zero the analyzer's room-air/primary-air temperature channel.
3. Set the simulator to 32 °F (0 °C).*
4. Wait until the MEASURED reading on the screen stabilizes. Then use the **set** and **ENTER** keys to enter an APPLIED value that equals 32 °F (0 °C).

Typical Calibrate TA-Zero Screen During Calibration Procedure:

CALIBRATE TA-ZERO	
MEASURED	37.0°F
APPLIED	0032.0°F

4. Press the **run** key to calibrate the analyzer's MEASURED value to that of the APPLIED value. At this time the Calibrate Menu Screen is redisplayed.

* The TA-Zero calibration range is 0 – 5 °C (32 – 41 °F). Any attempt to calibrate outside this range will cause the analyzer to display the message BAD CALIBRATION ENTRY.

5.7 Calibrate TA-Span

Material Required:

- Thermocouple Simulator (K-type) Range: 0 to 600 °F
Accuracy: ± 0.5 °F

Procedure:

1. With the analyzer turned off, first plug the simulator's K-type connector into the T-AIR jack (Figure 3-2); then turn on the analyzer and wait for its warm-up cycle to complete.
2. Enter the Calibration Menu Screen per Section 5.3; then choose TA-SPAN to span the analyzer's room-air/primary-air temperature channel.
3. Set the simulator to 212 °F (100 °C).*
4. Wait until the MEASURED reading on the screen stabilizes. Then use the **set** and **ENTER** keys to enter an APPLIED value that equals 212 °F (100 °C).

Typical Calibrate TA-Span Screen During Calibration Procedure:

CALIBRATE TA-SPAN	
MEASURED	209.0°F
APPLIED	0212.0°F

4. Press the **run** key to calibrate the analyzer's MEASURED value to that of the APPLIED value. At this time the Calibrate Menu Screen is redisplayed.

* The TA-Span calibration range is 194 – 230 °F (90 – 110 °C). Any attempt to calibrate outside this range will cause the analyzer to display the message BAD CALIBRATION ENTRY.

5.8 Calibrate NX

(For PCA Models 30, 35, 60 & 65)

The Nitric Oxide sensor needs to be spanned at regular intervals to determine if the analyzer still meets its accuracy specification. Because of the toxicity of Nitric Oxide gas, however, unless your facility has the necessary gas cylinders and personnel trained in the handling of toxic gases, we recommend that the Nitric Oxide sensor be spanned by an authorized Bacharach Service Center.

Material Required:

- Calibration Gas Fixture (Section 5.2)
- Gas Cylinder, 50 to 150 ppm Nitric Oxide with an analytical accuracy of $\pm 1\%$ (customer supplied)

Procedure:

1. Enter the Calibrate Menu Screen per Section 5.3. Then choose to calibrate the NX sensor.
2. At the conclusion of Step 1 the pump should start running.
3. Using the Gas Fixture shown in Figure 5-1, attach the Nitric Oxide calibration-gas cylinder to the analyzer's GAS inlet.
4. Adjust the regulator of the calibration fixture for a flowmeter indication of approximately 2 SCFH.
5. Wait until the MEASURED reading on the screen stabilizes (approximately 3 minutes). Then use the **set** and **ENTER** keys to enter an APPLIED value* that equals the concentration that is stamped on the NX calibration-gas cylinder.

Typical Calibrate NX Screen During Calibration, Using 100 ppm Nitric Oxide Calibration Gas:

CALIBRATE NX	
MEASURED	092 PPM
APPLIED	0100 PPM

6. Press the **run** key to calibrate the analyzer's MEASURED value to that of the APPLIED value. At this time the Calibrate Menu Screen is redisplayed.

* The NX calibration range is 50 – 150 ppm. Any attempt to calibrate outside range will cause the analyzer to display the message BAD CALIBRATION ENTRY.

5.9 Calibrate CO

(For PCA Models 20, 25, 30, 35, 50, 55, 60 & 65)

Material Required:

- Calibration Gas Fixture (Section 5.2)
- Gas Cylinder, 500 ppm CO in air (Refer to Section 8.2)
- Gas Cylinder, CO (1000 ppm) and H₂ (1000 ppm) in Nitrogen (Refer to Section 8.2)

Procedure:

1. Enter the Calibrate Menu Screen per Section 5.3. Then choose to calibrate the CO sensor.
2. At the conclusion of Step 1 the pump should start running.
3. Using the Gas Fixture shown in Figure 5-1, attach the CO calibration-gas cylinder to the analyzer's GAS inlet.
4. Adjust the regulator of the calibration fixture for a flowmeter indication of approximately 2 SCFH.
5. Wait until the MEASURED reading on the screen stabilizes (approximately 3 minutes). Then use the \leftarrow and ENTER keys to enter an APPLIED value* that equals the concentration which is stamped on the CO calibration-gas cylinder.

Typical CALIBRATE CO Screen During Calibration Procedure, Using 500 ppm CO Calibration Gas:

CALIBRATE CO	
MEASURED	492 PPM
APPLIED	0500 PPM

6. Press the RUN key to calibrate the analyzer's MEASURED value to that of the APPLIED value. At this time the Test Gas CO/H₂ Screen is displayed.

* The CO calibration range is 250 – 1500 ppm. Any attempt to calibrate outside this range will cause the analyzer to display the message BAD CALIBRATION ENTRY.

7. Turn off the flow of CO calibration-gas; then remove the calibration-gas cylinder from the calibration fixture.
8. Attach a CO/H₂ calibration-gas cylinder to the calibration fixture; then adjust the regulator of the calibration fixture for a flowmeter reading of approximately 2 SCFH.
9. Use the **set** and **ENTER** keys to enter a CO-VALUE that is the same as the CO concentration which is stamped on the CO/H₂ calibration-gas cylinder.

Typical Test Gas CO/H2 Screen During Calibration Procedure:

```
TEST GAS CO/H2
-----
CO-VALUE      XXXX
ENTER CO-VALUE
```

10. Press the **run** key to save the CO-VALUE and display the Calibrate H2 Screen.
11. After calibration gas has been applied for approximately 3 minutes (to allow for stabilization), use the **set** and **ENTER** keys to enter an **APPLIED** value* that equals the H₂ concentration which is stamped on the CO/H₂ calibration-gas cylinder.

Typical CALIBRATE H2 Screen During Calibration Procedure:

```
CALIBRATE H2
MEASURED  1050 PPM
APPLIED   1000 PPM
```

12. Press the **run** key to calibrate the analyzer's **MEASURED** value to that of the **APPLIED** value. At this time the Calibrate Menu Screen is redisplayed.

* The H₂ calibration range is 500–1500 ppm, any attempt to calibrate outside this range will cause the unit to display the message **BAD CALIBRATION ENTRY**.

5.10 Calibrate Draft

(For PCA Models 15, 25, 35, 45, 55 & 65)

Material Required:

- Calibration Fixture (Section 5-2)
- Bellows (adjustable)
- Micromanometer Range: ± 8 in. H₂O column (± 20 mb)
 Accuracy: ± 0.01 in. H₂O column (± 0.025 mb)

Procedure:

Important! *In Step 1, **do not** connect the draft calibration fixture to the analyzer until the Calibrate Draft Screen has been selected and displayed.*

1. Enter the Calibrate Menu Screen per Section 5.3. Then choose to calibrate the draft sensor.
2. With the Calibrate Draft Screen displayed, connect the hose from the calibration fixture to the analyzer's DRAFT port; then adjust the bellows for a micromanometer reading of -4 " H₂O column (-10 mb).
3. Wait until the MEASURED reading on the screen stabilizes. Then use the **st** and **ENTER** keys to enter an APPLIED reading* which equals the Micromanometer reading.

Typical CALIBRATE DRAFT Screen During Calibration Procedure:

CALIBRATE DRAFT	
MEASURED	- 9.00 WC
APPLIED	- 4.00 WC

4. Press the **run** key to calibrate the analyzer's MEASURED value to that of the APPLIED value. At this time the Calibrate Menu Screen is redisplayed.

* The draft calibration range is from -2 to -6 inches of water column (-5 to -15 mb), any attempt to calibrate outside this range will cause the analyzer to display the message BAD CALIBRATION ENTRY.

NOTES:

6.0 MAINTENANCE

6.1 Routine Maintenance

Routine maintenance of the analyzer consists of: replacing the batteries, cleaning the probe, draining the water trap, replacing the water trap filter, and performing periodic calibration checks to ensure that the analyzer is providing accurate readings.

- Replace the Batteries per Section 3.2
- Clean the Probe per Section 6.3
- Maintain the Water Trap/Filter Assembly per Section 6.4
- Replace the Particulate Filter per Section 6.5
- Calibrate the analyzer per Section 5.0

6.2 Disassembly

Perform the following when a maintenance procedure calls for removing the case, printed circuit board, pump, or sensors:

1. Remove the batteries (Section 3.2.1)
2. Place the analyzer face down on a work surface, then remove the unit's four rear-case screws.
3. Carefully lift the rear case from the analyzer, unplug the battery compartment wires, then place the rear housing on a work surface (see Figures 6-1 & 6-2).

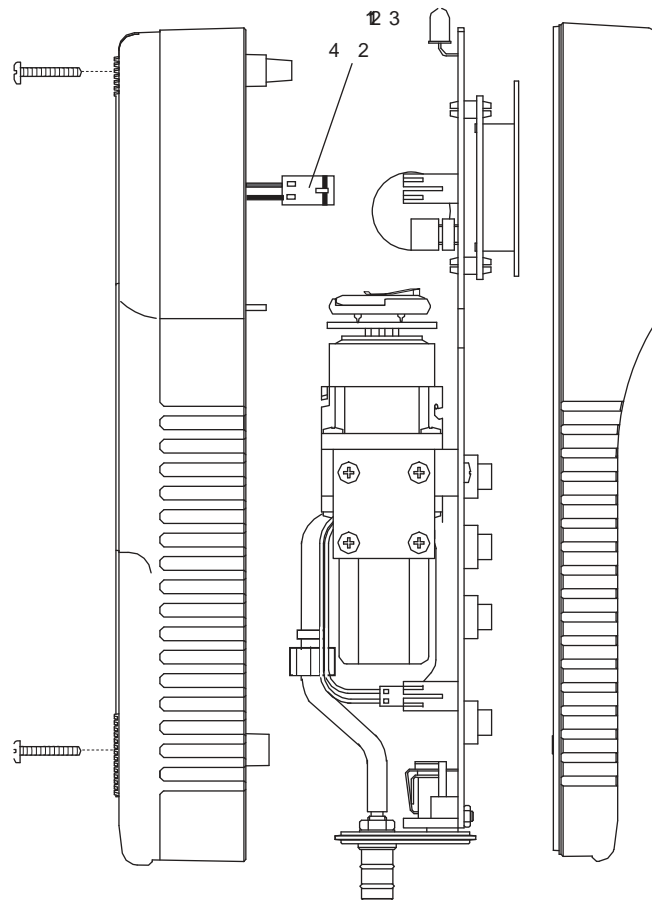

Figure 6-1. Disassembling the Analyzer

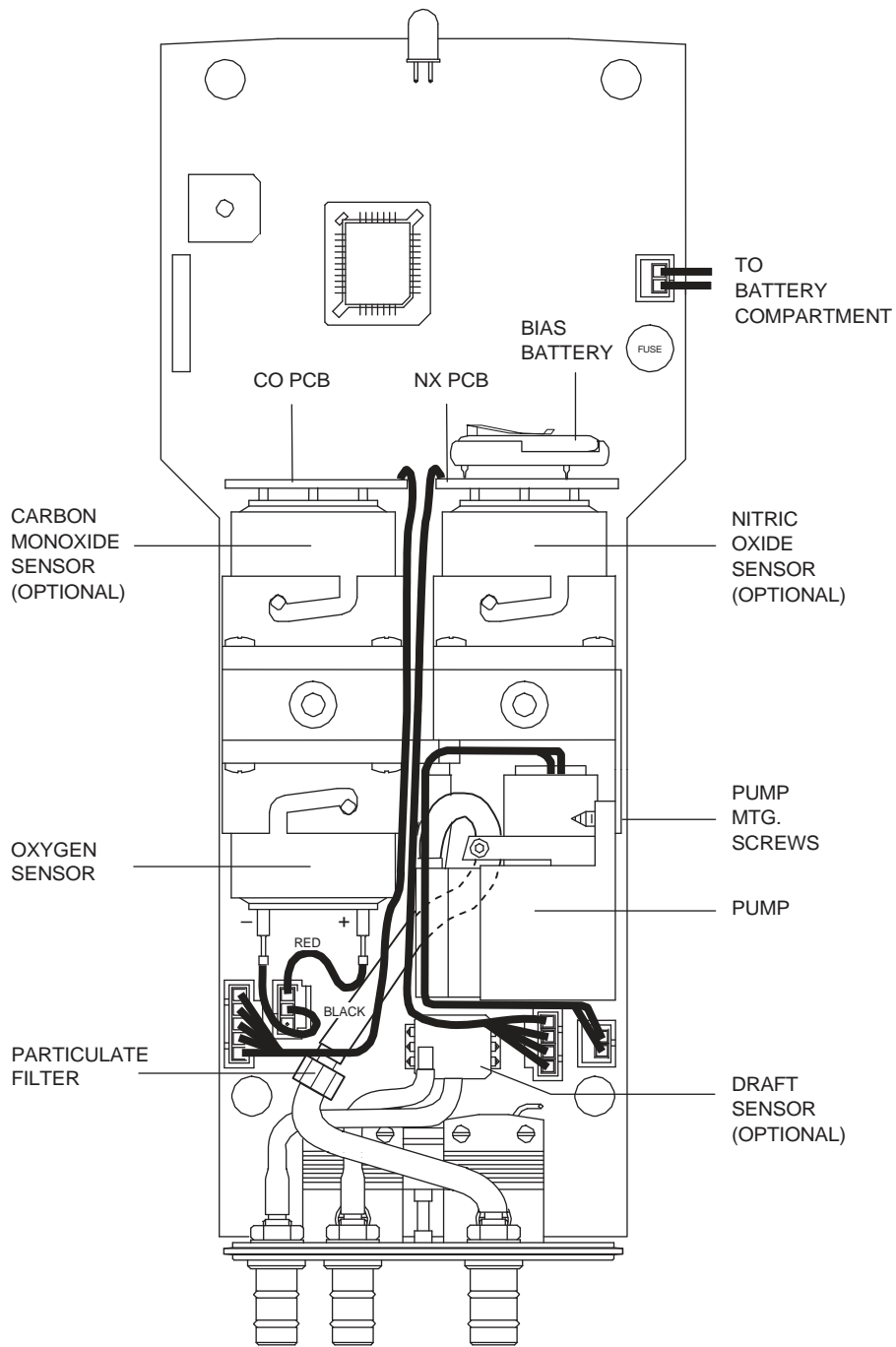

Figure 6-2. PCB and Sensors

6.3 Cleaning the Probe

The Probe Tube and the Probe Body will become dirty under normal use (the water trap's filter element should prevent soot from reaching the analyzer's internal components). If the probe assembly is not kept clean, it could become clogged and restrict the flow of gas to the analyzer, resulting in incorrect readings and calculations.

NOTE: *An analyzer that is used to sample natural-gas furnaces normally requires less frequent cleaning than an analyzer used to sample oil or coal fired furnaces.*

Equipment Required:

- Alcohol
- Aerosol can of Automotive Carburetor Cleaner
- Clean Rag
- Source of Compressed Air (optional)

Procedure:

1. Remove the rubber tubing from the barbed fitting(s) on the probe handle (Figure 3-2).

CAUTION:

Carburetor cleaner attacks plastic components. Take precautions not to spray cleaner onto the probe handle or analyzer.

2. Insert the plastic-spray tube of the carburetor cleaner into the barbed fitting(s) of the probe handle; then liberally spray carburetor cleaner through the probe.
3. After spraying, remove all the residual cleaner by repeatedly flushing the probe with alcohol.
4. Wipe off the surfaces of the probe and tubing with a clean rag.
5. Allow the parts to dry completely. If available, blow compressed air through the probe to expedite the drying process.
6. Reassemble the parts of the probe assembly.

6.4 Water Trap/Filter Assembly Maintenance

The Water Trap / Filter Assembly removes water condensate from the gas sample, and also prevents soot from contaminating the internal components of the analyzer.

Drain the water condensate after every use.

Procedure:

1. Pull off the end-cap from the Inlet End of the Water Trap / Filter Assembly (Figure 6-3).
2. Pour out all of the water condensate, and replace the end-cap.

Replace the filter element when it becomes excessively dirty.

Equipment Required:

- Filter Element (Refer to Section 8.1)

Procedure:

1. Pull off the end-cap from the Outlet End of the Water Trap / Filter Assembly (Figure 6-3).
2. Remove and discard the old filter element.
3. Install a new filter element and replace the end-cap.

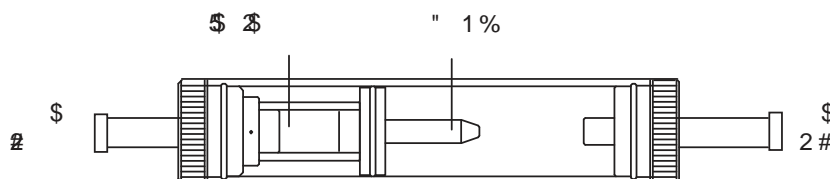

Figure 6-3. Water Trap/Filter Assembly

6.5 Replacing the Particulate Filter

The internal particulate filter (Figure 6-2) prevents small dust and dirt particles from entering and damaging the pump. Depending on your environmental conditions, it is recommended to change the particulate filter and fitting approximately every six months, or sooner if it becomes clogged.

Equipment Required:

- Particulate Filter and Fitting (Refer to Section 8.1)

Procedure:

1. Remove the analyzer's rear case and lay it aside (refer to Section 6.2).
2. Carefully pull off the 1/8" ID tubing from the filter and fitting. Note the orientation of tubing and fitting before removing.
3. Remove and discard the old filter and fitting and replace with new ones. Be careful not to not pinch the tubing during reassembly.
4. Reassemble the analyzer in the reverse order of disassembly.

6.6 Replacing the Oxygen Sensor

Replace the Oxygen Sensor when it has expired (when the analyzer's automatic O₂ calibration fails and the unit displays the message "O₂-Sensor Error").

NOTE: A "O₂-SENSOR ERROR" displayed in the Sensor Status Screen does not necessarily mean that the sensor has expired. Before replacing the sensor, refer to Section 7.2 for other possible causes of the error.

Equipment Required:

- 1/8" Flat Blade Screw Driver
- Oxygen Sensor (Refer to Section 8.1)

Procedure:

1. Remove the analyzer's rear case and lay it aside (refer to Section 6.2).
2. Remove the Oxygen Sensor connector from the printed circuit board; then carefully pull off the two wires connected to the pins of the sensor (see Figure 6-2).
3. Push in and turn the sensor counterclockwise (watching the notch on top) until it stops; then pull the sensor out of its housing.
4. To install a new sensor, push the sensor into the housing and turn it clockwise until it locks in place.
5. Connect the black (–) and red (+) wires, which were removed from the old sensor in Step 2, to the pins of the new sensor. Be sure to observe polarity as marked on the sensor.
6. Reinstall the sensor connector onto the printed circuit board.
7. Reassemble the analyzer. Then allow the sensor to be connected in the circuit for at least *1 hour* before continuing.
8. Place the analyzer in an area of fresh air and turn it ON. After the warmup cycle, observe that the Sensor Status Screen should no longer show an O₂ sensor error.

6.7 Replacing the Nitric Oxide Sensor

(For PCA Models 30, 35, 60 & 65)

Replace the Nitric Oxide sensor when it has expired (can no longer be calibrated).

NOTE: A "NX-SENSOR ERROR" displayed in the Sensor Status Screen does not necessarily mean that the sensor has expired. Before replacing the sensor, refer to Section 7.2 for other possible causes of the error.

Equipment Required:

- 1/8" Flat Blade Screw Driver
- Nitric Oxide Sensor (Refer to Section 8.1)
- Nitric Oxide Sensor Filter (Refer to Section 8.1)

Procedure:

1. Remove the analyzer's rear case and lay it aside (refer to Section 6.2).
2. Carefully pull the printed circuit board off the rear of the Nitric Oxide sensor (see Figure 6-2).
3. Push in and turn the sensor counterclockwise (watching the notch on top) until it stops; then pull the sensor out of its housing.
4. Install a new sensor by first pushing it into its housing, and then turning it clockwise until it locks in place.
5. Install the circuit board, which was removed in Step 2, onto the rear of the sensor.
6. Reassemble the analyzer and allow the sensor to be connected in the circuit for at least 4 hours before continuing.
7. Place the analyzer in an area of fresh air and turn it ON.
8. Calibrate the analyzer per Section 5.0.

6.7.1 Replacing the Nitric Oxide Sensor Filter

To increase the life of the Nitric Oxide sensor, it is recommended its orange filter be replaced once a year.

Procedure:

1. Remove the Nitric Oxide sensor per Section 6.7.
2. Pry the orange filter from the Nitric Oxide sensor and replace it with a new one.
3. Reinstall the sensor.

6.7.2 Replacing the Nitric Oxide Sensor Bias Battery

A single lithium battery, located on the Nitric Oxide printed circuit board (see Figure 6-2), applies a constant bias voltage to the Nitric Oxide sensor even while the instrument is turned off. This battery has a life expectancy of at least 2 years.

Replace the Nitric Oxide bias battery toward the end of its expected life.

Equipment Required:

- Bias Battery (See Section 8.1)

Procedure:

1. Remove the analyzer's rear case and lay it aside (refer to Section 6.2).
2. Remove old battery from its holder (see Figure 6-2).
3. Insert the new battery (positive side facing upwards) into its holder.
4. Reassemble the analyzer.
5. Before powering up and using the instrument, allow the Nitric Oxide sensor to stabilize as described below. Recalibration of the Nitric Oxide sensor is usually not required.

Depending on how long the Nitric Oxide sensor was without bias voltage, the time required for the sensor to completely stabilize varies from less than a minute to several days. Typical stabilization times are shown below. Generally, however, the sensor is sufficiently stable after 4 hours for measurement purposes.

Bias removed for . .	Stabilization time
Less than 15 min.	Less than 1 min.
Less than 1 hr.	Less than 5 min.
Less than 2 days	Less than 4 hr.
Greater than 2 days	Up to 2 days

6.8 Replacing the Carbon Monoxide Sensor

(For PCA Models 20, 25, 30, 35, 50, 55, 60 & 65)

Replace the Carbon Monoxide sensor when it has expired (can no longer be calibrated).

NOTE: A "CO-SENSOR ERROR" displayed in the Sensor Status Screen does not necessarily mean that the sensor has expired. Before replacing the sensor, refer to Section 7.2 for other possible causes of the error.

Equipment Required:

- 1/8" Flat Blade Screw Driver
- Carbon Monoxide Sensor (Refer to Section 8.1)
- Carbon Monoxide Sensor Filter (Refer to Section 8.1)

Procedure:

1. Remove the analyzer's rear case and lay it aside (refer to Section 6.2).
2. Carefully pull the printed circuit board off the rear of the Carbon Monoxide sensor (see Figure 6-2).
3. Push in and turn the sensor counterclockwise (watching the notch on top) until it stops; then pull the sensor out of its housing.
4. Remove the wire jumper from the pins of the new sensor.
5. Install the new sensor by first pushing the sensor into its housing, and then turning clockwise until it locks in place.
6. Install the circuit board, which was removed in Step 2, onto the rear of the sensor.
7. Reassemble the analyzer; then allow the sensor to be connected in the circuit for at least *1 hour* before continuing.
8. Place the analyzer in an area of fresh air and turn it ON.
9. Calibrate the analyzer per Section 5.0.

6.8.1 Replacing the Carbon Monoxide Sensor Filter

To increase the life of the Carbon Monoxide sensor, it is recommended its red filter be replaced once a year .

Procedure:

1. Remove the Carbon Monoxide sensor per Section 6.8.
2. Pry the red filter from the Carbon Monoxide sensor and replace it with a new one.
3. Reinstall the sensor.

6.9 Replacing the Pump Assembly

Replace the Pump Assembly if it is found to be defective.

Equipment Required:

- 1/8" Flat Blade Screw Driver
- No. 1 Phillips Screw Driver
- Pump Assembly (Refer to Section 8.1)

Procedure:

1. Remove the analyzer's rear case and lay it aside (refer to Section 6.2).
2. Remove the two self tapping Phillips screws holding the Pump Assembly (See Figure 6-2).
3. Unplug the pump connector from the printed circuit board; slide off the two hoses from the pump noting their orientation; then remove the entire assembly.
4. Install the new assembly and reassemble the analyzer in the reverse order of disassembly.

7.0 TROUBLESHOOTING

7.1 Analyzer Repair

It is recommended that field repair of the PCA be limited to:

- Simple checks of the printed circuit boards
- Replacing the Probe Assembly
- Replacing the filter element in the Water Trap / Filter Assembly
- Replacing the Particulate Filter
- Replacing the Pump Assembly
- Replacing Sensors and Sensor Filters
- Replacing Batteries

All other repairs should be performed by an authorized Bacharach Service Center. Any repairs performed by an *unauthorized* service organization will void the analyzer's warranty and release Bacharach, Inc. of any implied or written product liability.

Before returning your analyzer for repair, you may be able to determine and resolve a problem using the Troubleshooting Guide in Section 7.3.

7.2 Error Codes

If one of the following messages or symbols is displayed, refer to Section 7.3 *Troubleshooting Guide* for information on how to correct the error.

O2 - SENSOR ERROR	O ₂ Sensor not connected, or is expired, or was exposed to combustion gases during warmup.
CO - SENSOR ERROR	Carbon Monoxide sensor is expired, or was exposed to Carbon Monoxide during warmup.
NX - SENSOR ERROR	Nitric Oxide sensor is expired, or was exposed to Nitric Oxide during warm up, or the bias battery is dead.
TA-SENSOR ERROR	Room air thermocouple is outside the range of -20 to 100 °C (-4 to 212 °F)
TS-SENSOR ERROR	Flue Gas thermocouple is not connected or is outside the range of -20 to 1200 °C (-4 to 2192 °F)
DRAFT-SENSOR ERROR	Outside the range of - 3 to + 3 inches of water column (-7.5 to +7.5 mb)
LOW BATTERY	Battery voltage has dropped below 3.9 volts. The instrument will shut off when battery voltage drops below 3.5 volts.
BAD CALIBRATION ENTRY	An attempt was made to enter a calibration value that was outside the analyzer's acceptable limits
"_ _ _ _"	Not calculated (O ₂ above 16%, or stack temperature above 1000 °C (1832 °F)).
"* * * *"	Sensor not installed or sensor error
"XXXX"	Overrange (numeric)

7.3 Troubleshooting Guide

The following table lists the most common analyzer faults, causes and remedies. For help with any problem not discussed here, please contact the nearest Bacharach Service Center per Section 8.3.

TABLE 7-1. TROUBLESHOOTING GUIDE

Fault	Probable Cause & Remedy
Analyzer completely nonfunctional; won't turn on when the ON/OFF key is pressed.	<ul style="list-style-type: none"> a. Batteries dead. Replace batteries per Section 3.2. b. Loose battery connector. Disassemble analyzer and ensure that the battery connector is attached to the printed circuit board. c. Microprocessor needs to be reset. Press RESET button (Fig. 4-7). d. Optional Power Supply defective. Replace Power Supply. e. Analyzer defective. Return to Bacharach for repair.
Display Screen is blank when analyzer is turned on, but pump runs during warmup cycle.	<ul style="list-style-type: none"> a. Microprocessor needs to be reset. Press RESET button (Fig. 4-7). b. Analyzer defective. Return to Bacharach for repair.
LOW BATTERY message appears at bottom of display.	Batteries close to being discharged. Analyzer will run for several minutes before the instrument shuts off. Replace batteries per Section 3.2.1.
O₂-SENSOR ERROR code appears in the Sensor Status Screen.	<ul style="list-style-type: none"> a. Calibration was attempted while sampling combustion gases. b. O₂ sensor is either expired, not wired correctly, or not connected to the circuit board. Replace or check wiring of sensor per Section 6.6.

TABLE 7-1. TROUBLESHOOTING GUIDE (Cont.)

Fault	Probable Cause & Remedy
<p>NX-SENSOR ERROR code appears in the Sensor Status Screen.</p>	<ul style="list-style-type: none"> a. Calibration was attempted while sampling combustion gases. b. Nitric Oxide sensor is expired. Replace sensor per Section 6.7. c. Bias battery on the Nitric Oxide circuit board is dead. Replace battery per Section 6.7.2.
<p>CO-SENSOR ERROR code appears in the Sensor Status Screen.</p>	<ul style="list-style-type: none"> a. Calibration was attempted while sampling combustion gases. b. Carbon Monoxide sensor is expired. Replace sensor per Section 6.8.
<p>DRAFT-SENSOR ERROR code appears in the Sensor Status Screen.</p>	<ul style="list-style-type: none"> a. Sensor was exposed to pressure outside of its detectable range. b. Sensor defective. Return analyzer to Bacharach for repair.
<p>T-STACK OR T-AIR SENSOR ERROR code appears in the Sensor Status Screen.</p>	<ul style="list-style-type: none"> a. Calibration was attempted while sampling combustion gases. b. Thermocouple not connected. Connect thermocouple to analyzer per Section 3.3. c. Thermocouple defective. Replace probe assembly. d. Instrument was exposed to temperatures outside it's allowable operating range.
<p>BAD CALIBRATION ENTRY message appears during calibration.</p>	<p>Apply a calibration value that is within the range of the sensor as listed in the calibration procedure.</p>

TABLE 7-1. TROUBLESHOOTING GUIDE (Cont.)

Fault	Probable Cause & Remedy
“****” appears in one or more value fields.	The field’s associated sensor is not installed.
“- - -” appears in one or more value fields of the Combustion Test Screen.	<p>a. The analyzer is not able to calculate a numerical value based on measured combustion data. The “- - -” is replaced with numerical values when the analyzer begins to detect valid combustion data.</p> <p>b. Sensor in error during warm-up. The field’s associated sensor is detecting a value that is outside the analyzer’s detection range. “XXXX” is replaced with numerical data when the analyzer detects values that fall within its range. Microprocessor needs to be reset. Press RESET button (Fig. 4-7).</p>
“XXXX” appears in one or more value fields.	<p>a. Flow restricted. Check that the filter element in the Water Trap/Filter Assembly is clean and not saturated with water (Fig. 6-3). Also, verify that the probe hose is not pinched.</p> <p>b. Flow restricted. Check the Particulate Filter is clean and not blocked (Fig. 6-2).</p> <p>c. Loose pump connection. Disassemble analyzer and ensure that the pump connector is securely attached to the circuit board</p> <p>d. Pump defective. Replace pump assembly.</p>
Analyzer won’t respond when a panel key is pressed.	
Pump motor sounds sluggish, stalls, or will not start.	

TABLE 7-1. TROUBLESHOOTING GUIDE (Cont.)

Fault	Probable Cause & Remedy
Backlight will not turn on.	Backlight LED burned out. Return to Bacharach for repair.
Batteries do not last 10 hours.	Cold temperature is reducing battery capacity. To obtain longer operating time, keep analyzer warm.
Erratic Combustion Test Screen values.	<p>a. Faulty sensor(s):</p> <ul style="list-style-type: none"> - Check that the sensors are properly installed per Sections 6.6 through 6.8. - Check sensor calibration per Section 5.0. - Replace sensor(s) and recalibrate per Sections 5.0 and 6.0. <p>b. Probe assembly leaking. Check tightness of all hose connections and integrity of tubing.</p> <p>c. Pump defective. Replace pump & motor assembly.</p> <p>d. Analyzer defective. Return to Bacharach for repair.</p>
Analyzer will not calibrate properly.	<p>a. Wrong calibration gas or insufficient flow being applied to sensor. Ensure your calibration setup is correct.</p> <p>b. Faulty sensor. Replace sensor and recalibrate per Sections 5.0 and 6.0.</p> <p>c. Analyzer defective. Return to Bacharach for repair.</p>

8.0 PARTS & SERVICE

8.1 Replacement Parts

Item (Figure 8-1)	Description	Part No.
1	Battery Cover	0024-0784
2	Screw, Case Housing	0501-3824
3	Screw, Pump Mounting	0501-3822
8	Oxygen Sensor	0024-0788
9	Carbon Monoxide Sensor	0024-0789
10	Nitric Oxide Sensor	0024-0881
11	Carbon Monoxide Sensor Filter	0024-0863
12	Nitric Oxide Sensor Filter	0024-0862
13	Pump Assembly	0024-3009
14	Fuse, 1.25A, 250V	0604-2605
15	Battery, Nitric Oxide Sensor Bias	0204-0020
16	Particulate Filter	0007-1600
17	Fitting, for Particulate Filter	0103-5267
18	O-Ring, 7mm OD x 1mm wall	0105-5103
19	O-Ring, 8mm OD x 1mm wall	0105-5102
24	Filter Element (white)	0007-1644
25	Draft Connector, Probe	0024-0878
26	Gas Connector, Probe	0024-0877
27	Filter Assembly (complete)	0024-1107

8.2 Accessories

Description	Part No.
STANDARD ACCESSORIES:	
Battery, "AA" Alkaline	0204-0004
Complete Probe and Hose Assembly (Gas & Draft)	0024-3004
Instruction Manual	0024-9219
Plastic Carrying Case	0024-1078
OPTIONAL ACCESSORIES:	
Ambient Thermocouple, 10 ft. K-type	0104-1797
Ambient Thermocouple, 1 in. K-type	0104-1798
Bent Probe Tip	0024-8039
Calibration Kit	0024-7059
Differential Pressure Hose Assembly	0024-1103
Gas Cylinder, 500 ppm CO in air	0024-0492
Gas Cylinder, 1000 ppm CO & 1000 ppm H ₂ in Nitrogen	0024-0794
Printer, Infrared (with Manual, Batteries, and Paper):	
120 VAC	0024-1229
230 VAC	0024-1230
Printer Paper (1 roll)	0024-0887
Power Supply Adapter, 110 VAC	0024-0885
Regulated Power Supply Adapter, 230 VAC	0024-1209
Serial Communication Cable	0024-1073

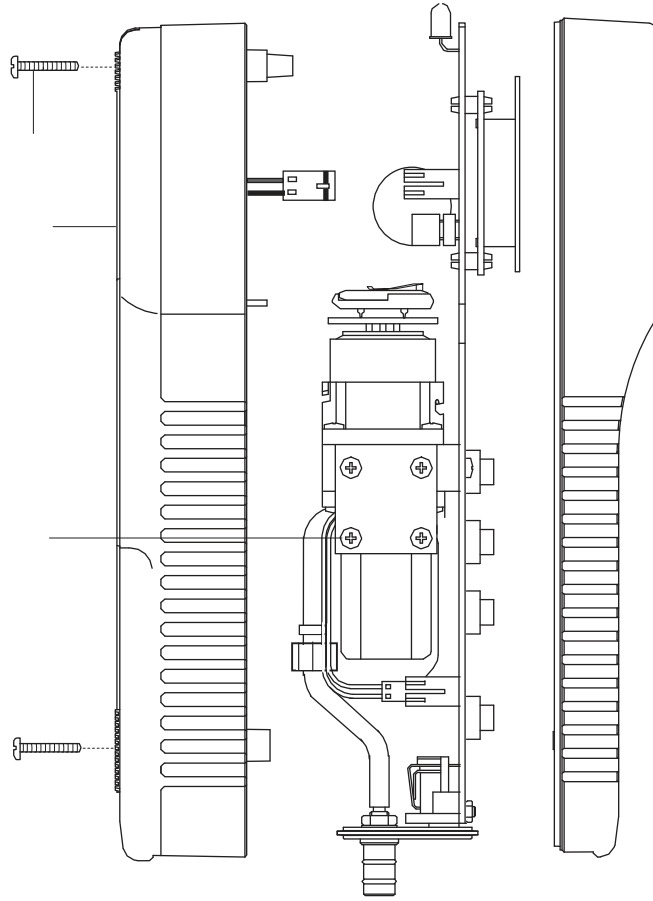

Figure 8-1. Replacement Parts (1 of 3)

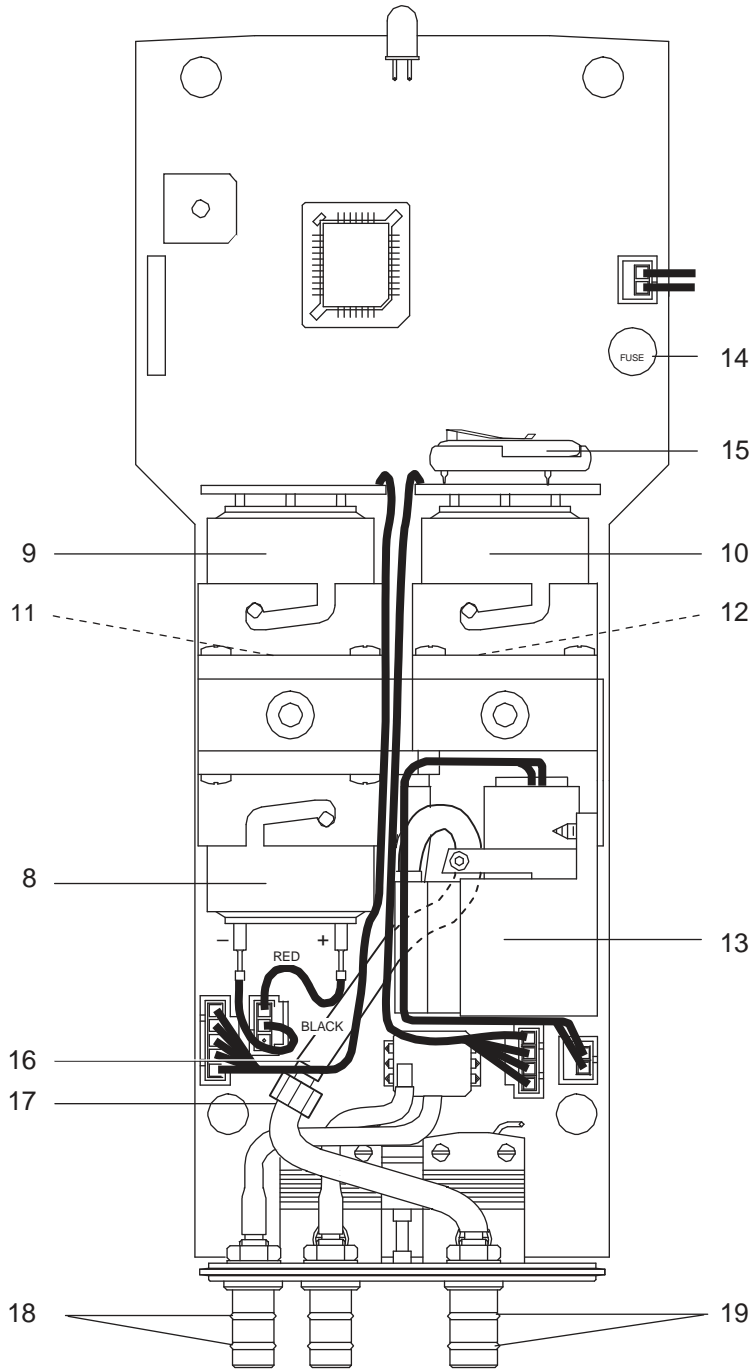

Figure 8-1. Replacement Parts (2 of 3)

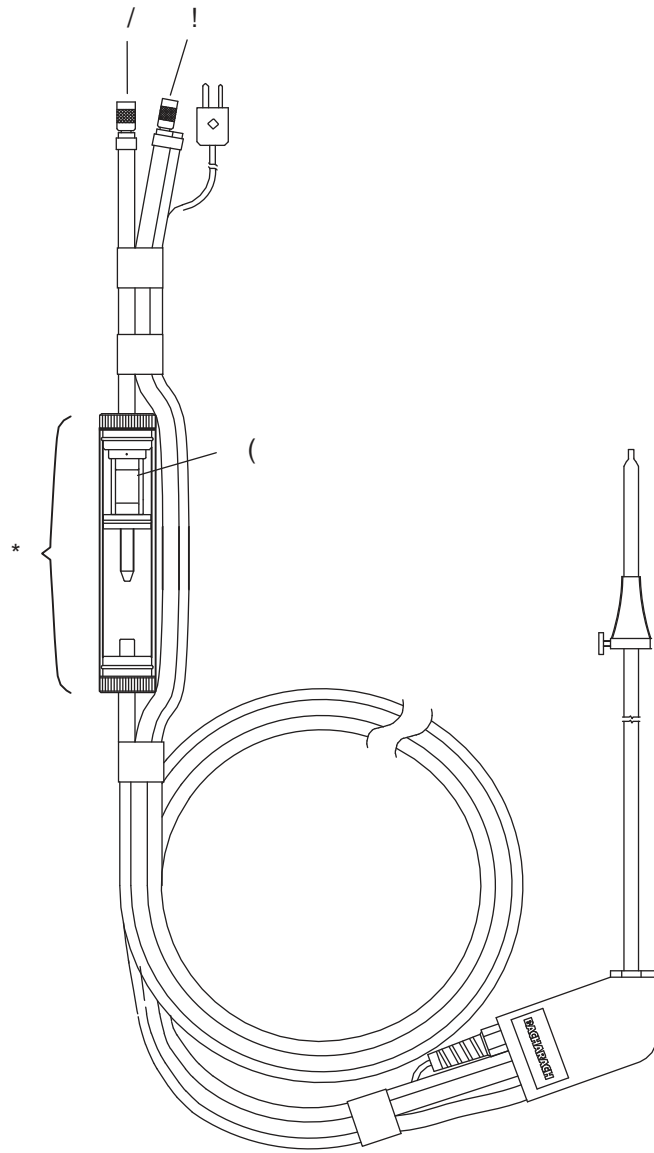

Figure 8-1. Replacement Parts (3 of 3)

8.3 Service Centers

United States

Bacharach, Inc.
621 Hunt Valley Circle
New Kensington, PA 15068
Phone: 724-334-5051
Fax: 724-334-5723
Email: help@bacharach-inc.com

Canada

Bacharach of Canada, Inc.
20 Amber St. Unit #7
Markham, Ontario L3R SP4
Canada
Phone: 905-470-8985
Fax: 905-470-8963
Email: bachcan@idirect.com

APPENDIX A

Display Screen Translations

English

French

Spanish

Warm Up Screen

BACHARACH, INC.
PCA nn
Warmup nn

BACHARACH, INC.
PCA nn
ECHAUFFEMENT nn

BACHARACH, INC.
PCA nn
CALENTAMIENTO nn

Sensor Status Screen (Errors)

NO ERRORS DETECTED
LOW BATTERY
O2-SENSOR ERROR
CO-SENSOR ERROR
DRAFT-SENSOR ERROR
T-STACK SENSOR ERROR
T-AIR SENSOR ERROR
NX-SENSOR ERROR

PAS D D'ERREUR RELEVÉE
BATTERIE FAIBLE
ERREUR CELLULE O2
ERREUR CELLULE CO
ERREUR CELLULE PRESS
ERR. CELLULE T. CHEMI.
ERR. CELLULE T. AIR
ERREUR CELLULE NX

NO ERROR DETECTADO
BATERIA BAJA
ERROR EN SENSOR O2
ERROR EN SENSOR CO
ERROR EN SENSOR DRFT
ERROR SENSOR T-CHIM
ERROR SENSOR T-AIRE
ERROR EN SENSOR NX

Sign Off Screen

OFF IN n SEC
PURGING CO SENSOR

ARRET DANS n SEC
PURGE DETECTEUR CO

ADAGADO EN n SEGS
PURGANDO CO SENSOR

Combustion Test Screen (Abbreviations)

NG
O#2
O#4
O#6
KER
LPG
COL

GNA
H#2
H#4
H#6
KER
PRO
CAR

GN
A#2
A#4
A#6
KER
GLP
CAR

Fuel Selection Screen

FUEL
NATGAS
OIL #2
OIL #4
OIL #6
KEROSENE
PROPANE
COAL

COMBUST.
GAZ NATU
HUILE#2
HUILE#4
HUILE#6
KEROSENE
PROPANE
CARBON

COMBUST.
GNATURAL
ACEITE#2
ACEITE#4
ACEITE#6
KEROSINA
PROPANO
CARBON

Draft Screens

DRAFT
DISCONNECT DRAFT
HOSE
PRESS ENTER
RECONNECT DRAFT
HOSE
HOT SPOT

PRESSION
DEBRANCHER LE TUYAU
DE TIRAGE
APPUYER SUR ENTER
REBRANCHER LE TUYAU
DE TIRAGE
PT. CHAUD

DRAFT
DESCONECTE MANGUERA
DE ASPIRACION
OPRIMA ENTER
RECONECTE MANGUERA
DE ASPIRACION
HOT SPOT

English**French****Spanish****Saving Memory Screen**SAVING MEMORY
LOCATION nnGARDE LOCATION
MEMOIRE nnSALVANDO EN MEMORIA
LOCALIZACION nn**Memory Directory Screen**MEMORY DIRECTORY
MEMORY EMPTY
CLEAR MEMORYLISTE MEMOIRE
MEMOIRE VIDE
EFFACER MEMOIREDIRECTORIO MEM
MEMORIA VACIA
BORRAR MEMORIA**Draft Memory Screen**DRAFT MEM
DRAFTPRESSION MEM
PRESSIONMEMORIA DRAFT
DRAFT**Clear Memory Screen**

CLEAR MEMORY

EFFACER MEMOIRE

BORRAR MEMORIA

Memory to PC ScreenMEMORY TO PC
TRANSMIT DATA
CLEAR MEMORYMEMOROIRE A PC
TRANSM. DONNEES
EFFACER MEMOIREMEMORIA AL PC
TRANSMITIR DATOS
BORRAR MEMORIA**ID Setup Screen**SETUP
ID nPROGRAMME
ID nSETUP
ID n**Temperature Setup Screen**SETUP
TEMPERATURE UNITPROGRAMME
UNITE DE TEMPSETUP
UNIDADES TEMP**Draft Setup Screen**SETUP
DRAFT UNITPROGRAMME
UNITE DE PRESSSETUP
UNIDADES DRAFT**O₂ Reference Setup Screen**SETUP
O2 REFERENCEPROGRAMME
REFERENCE A O2SETUP
REFERENCIA O2**Language Setup Screen**SETUP
LANGUAGEPROGRAMME
LANGUESETUP
IDIOMA**Display Mode Setup Screen**SETUP
DISPLAYPROGRAMME
AFFICHERSETUP
VISUALIZAR

English**French****Spanish****Time/Date Setup Screen**

SETUP
TIME
DATE

PROGRAMME
HEURE
DATE

SETUP
HORA
FECHA

Printer Setup Screen

SETUP PRINTER
IR - HP
IR - IRDA
RS232

PROGRAMME PRINTER
IR - HP
IR - IRDA
RS232

SETUP PRINTER
IR - HP
IR - IRDA
RS232

Maintenance Password Screen

MAINTENANCE
PASSWORD

MAINTENANCE
MOT DE PASSE

MANTENIMIENTO
PASSWORD

Maintenance Screen

MAINTENANCE
CALIBRATION
USER NAME

MAINTENANCE
CALIBRAGE
USER NAME

MANTENIMIENTO
CALIBRACION
NOMBRE DEL USUARIO

Calibrate Menu Screen

CALIBRATE
TS-ZERO
TS-SPAN
TA-ZERO
TA-SPAN
NX
CO
DRAFT

CALBRAGE
TS-ZERO
TS-PTEE
TA-ZERO
TA-PTEE
NX
CO
PRESSION

CALIBRAR
TS-CERO
TS-SPAN
TA-CERO
TA-SPAN
NX
CO
DRAFT

Calibrate TS-Zero Screen

CALIBRATE TS-ZERO
MEASURED
APPLIED
BAD CALIBRATION ENTRY

CALIBRER TS-ZERO
MESUREE
APPLIQUEE
ERREUR D'ETALONNAGE

CALIBRAR TS-CERO
MEDIDO
APLICADO
CALIBRACION-INCORRECTA

Calibrate TS-Span Screen

CALIBRATE TS-SPAN
MEASURED
APPLIED
BAD CALIBRATION ENTRY

CALIBRER TS-POREE
MESUREE
APPLIQUEE
ERREUR D'ETALONNAGE

CALIBRAR TS-SPAN
MEDIDO
APLICADO
CALIBRACION-INCORRECTA

CalibrateTA-Zero Screen

CALIBRATE TA-ZERO
MEASURED
APPLIED
BAD CALIBRATION ENTRY

CALIBRER TA-ZERO
MESUREE
APPLIQUEE
ERREUR D'ETALONNAGE

CALIBRAR TA-CERO
MEDIDO
APLICADO
CALIBRACION-INCORRECTA

English**French****Spanish****Calibrate TA-Span Screen**

CALIBRATE TA-SPAN
 MEASURED
 APPLIED
 BAD CALIBRATION ENTRY

CALIBRER TA PORTEE
 MESUREE
 APPLIQUEE
 ERREUR D'ETALONNAGE

CALIBRAR TA-SPAN
 MEDIDO
 APLICADO
 CALIBRACION-INCORRECTA

Calibrate NX Screen

CALIBRATE NX
 MEASURED
 APPLIED
 BAD CALIBRATION ENTRY

CALIBRER NX
 MESUREE
 APPLIQUEE
 ERREUR D'ETALONNAGE

CALIBRAR NX
 MEDIDO
 APLICADO
 CALIBRACION-INCORRECTA

Calibrate CO Screen

CALIBRATE CO
 MEASURED
 APPLIED
 BAD CALIBRATION ENTRY

CALIBRER CO
 MESUREE
 APPLIQUEE
 ERREUR D'ETALONNAGE

CALIBRAR CO
 MEDIDO
 APLICADO
 CALIBRACION-INCORRECTA

Calibrate CO/H2 Screen

TEST GAS CO/H2
 CO VALUE
 ENTER CO VALUE
 BAD CALIBRATION ENTRY

GAZ TEST CO/H2
 VALEUR CO
 ENTRER VALEUR CO
 ERREUR D'ETALONNAGE

GAS PRUEBA CO/H2
 VALOR DE CO
 ENTRAR VALOR CO
 CALIBRACION-INCORRECTA

Calibrate H2 Screen

CALIBRATE H2
 MEASURED
 APPLIED
 BAD CALIBRATION ENTRY

CALIBRER H2
 MESUREE
 APPLIQUEE
 ERREUR D'ETALONNAGE

CALIBRAR H2
 MEDIDO
 APLICADO
 CALIBRACION-INCORRECTA

Calibrate DRAFT Screen

CALIBRATE DRAFT
 MEASURED
 APPLIED
 BAD CALIBRATION ENTRY

CALIBRER PRESSION
 MESUREE
 APPLIQUEE
 ERREUR D'ETALONNAGE

CALIBRAR DRAFT
 MEDIDO
 APLICADO
 CALIBRACION-INCORRECTA

User Name Screen

USER NAME
 LINE n

USER NAME
 LIGNE n

NOMBRE DEL USUARIO
 LINEA n

APPENDIX B – Printout Translations

English

French

Spanish

Combustion Test Data

[Line 1: user name]
 [Line 2: user name]
 [Line 3: user name]
 BACHARACH, INC.
 PCA 65
 SN: xxxxxx
 =====
 ID1: [optional data]
 ID2: [optional data]
 ID3: [optional data]
 TIME 04:27:35 pm
 DATE 02/24/1999

[Line 1: user name]
 [Line 2: user name]
 [Line 3: user name]
 BACHARACH, INC.
 PCA 65
 SN: xxxxxx
 =====
 ID1: [optional data]
 ID2: [optional data]
 ID3: [optional data]
 HEURE 04:27:35 pm
 DATE 02/24/1999

[Line 1: user name]
 [Line 2: user name]
 [Line 3: user name]
 BACHARACH, INC.
 PCA 65
 SN: xxxxxx
 =====
 ID1: [optional data]
 ID2: [optional data]
 ID3: [optional data]
 HORA 04:27:35 pm
 FECHA 02/24/1999

FUEL
 NATGAS
 STACK-TEMP 374 °F
 AMB.-TMP 68.0 °F
 O2 4.0 %
 CO2 9.5 %
 CO 12 ppm
 CO(0% O2) 15 ppm
 NX 10 ppm
 NX(0% O2) 12 ppm
 EFFICIENCY 82.6 %EX.
 AIR 21
 DRAFT -0.37 WC

COMBUST.
 GAZNATU
 TEMP-CHEMI 374 °F
 TEMP-AMBI 68.0 °F
 O2 4.0 %
 CO2 9.5 %
 CO 12 ppm
 CO(0% O2) 15 ppm
 NX 10 ppm
 NX(0% O2) 12 ppm
 EFFICACITE 82.6 %EX.
 AIR 21
 PRESSION -0.37 WC

COMBUST.
 GNATURL
 TEMP-CHIM 374 °F
 TEMP-AMB 68.0 °F
 O2 4.0 %
 CO2 9.5 %
 CO 12 ppm
 CO(0% O2) 15 ppm
 NX 10 ppm
 NX(0% O2) 12 ppm
 EFICIENCIA 82.6 %
 EXCESO AIR 21
 DRAFT -0.37 WC

 COMMENTS:

 COMMENT:

 COMENTARIO:

Draft Only

[Line 1: user name]
 [Line 2: user name]
 [Line 3: user name]
 BACHARACH, INC.
 PCA 65
 SN: xxxxxx
 =====
 ID1: [optional data]
 ID2: [optional data]
 ID3: [optional data]
 TIME 05:25:37 pm
 DATE 02/24/99
 DRAFT
 DRAFT -0.37 MB

 COMMENTS:

[Line 1: user name]
 [Line 2: user name]
 [Line 3: user name]
 BACHARACH, INC.
 PCA 65
 SN: xxxxxx
 =====
 ID1: [optional data]
 ID2: [optional data]
 ID3: [optional data]
 HEURE 05:25:37 pm
 DATE 02/24/99
 PRESSION
 PRESSION -0.37 WC

 COMMENT:

[Line 1: user name]
 [Line 2: user name]
 [Line 3: user name]
 BACHARACH, INC.
 PCA 65
 SN: xxxxxx
 =====
 ID1: [optional data]
 ID2: [optional data]
 ID3: [optional data]
 HORA 05:25:37 pm
 FECHA 02/24/99
 DRAFT
 DRAFT -0.37 WC

 COMENTARIO:

NOTES:

