

Type LS-20B Leak Standard



CONTENTS

	Page
CHECKING MATERIAL RECEIVED	2
DESCRIPTION	2
Components.....	4
OPERATION	5
Preparation for Operation	5
Applications.....	6
Operational Procedure.....	7
PRINCIPLES OF OPERATION.....	9
MAINTENANCE	10
Refilling Leak Standard	10
Replacing Leak Capillary.....	13
APPLICATION DATA	14
RENEWAL PARTS	16
SERVICE CENTERS.....	17

WARRANTY

The Type LS-20B Leak Standard is warranted to be free from defects in material or workmanship for a period of one year from the date of purchase.

If your Leak Standard requires servicing because of any defects in materials or workmanship, it will be serviced without charge. This warranty does not extend to servicing or repairs resulting from mis-handling, normal wear, or refilling.

The sole obligation of the Bacharach, Inc. shall be limited to repairing or replacing the Leak Standard or any part thereof, and in no event shall Bacharach, Inc. be liable for special or consequential damages.

CHECKING MATERIAL RECEIVED

The Type LS-20B Leak Standard, with accessories, is shipped in one carton. Check to see that you have received all items (see Fig. 1). Examine the Leak Standard immediately for any damage that may have occurred in transit. If damage is found, a damage claim should be filed with the transportation company, and the nearest Bacharach service center should be notified promptly.

DESCRIPTION

The Type LS-20B Leak Standard is a simple, accurate instrument which expels a halogen compound gas, Refrigerant-12 or Refrigerant-134a, through a glass capillary marked PROBE, to the atmosphere at a known rate. This known rate is adjustable when using an LS-20B Leak Standard. The Leak Standard is intended primarily for use with Bacharach halogen-sensitive leak detectors.

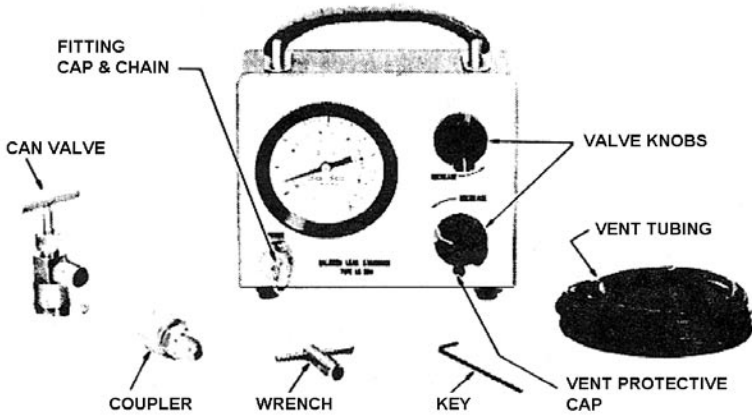

Fig. 1. Type LS-20B Leak Standard and Accessories

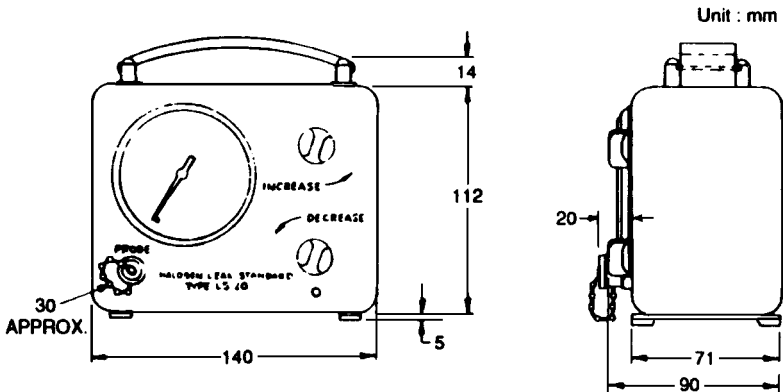

Fig. 2. Type LS-20B, Outline Dimensions

Type LS-20B Leak Standard

COMPONENTS

The Type LS-20B Leak Standard is a compact instrument consisting of the following seven functional components (see Fig. 3):

1. A direct reading LEAK RATE gage (calibrated in ounces of R-12 or R-134a per year).
2. A PROBE fitting in the center of which is a glass leak capillary. A different capillary is used for each leak rate.
3. An INCREASE valve and control knob.
4. A DECREASE valve and control knob.
5. A VENT (with protective cap) for exhausting R-12 /R-134a gas.
6. A TANK for holding liquid R-12 /R-134a.

NOTE: *The tank contains some R-12 / R-134a refrigerant when shipped from the factory.*

7. A Reservoir for holding R-12 / R-134a gas at a pressure corresponding to the desired leak rate.

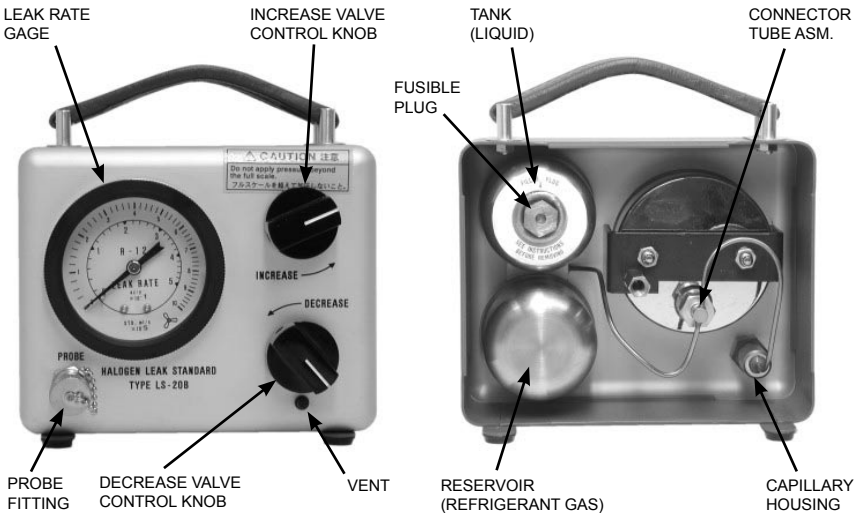

Fig. 3. Type LS-20B Leak Standard

OPERATION

PREPARATION FOR OPERATION

1. Remove the protective caps from the leak capillary in PROBE fitting and from the VENT.
2. To increase the leak rate, slowly turn the INCREASE valve knob counterclockwise until the instrument's LEAK RATE gage pointer starts to move up scale. As the pointer approaches the desired leak rate, gradually close the INCREASE valve so that the pointer will stop at the desired leak rate. If the instrument pointer continues to go up scale, this is an indication that the INCREASE valve is not closed, make sure the INCREASE valve is firmly closed.

CAUTION:

Avoid running the instrument pointer off scale. This can subject the instrument to as much as 500% overpressure. Although the unit can withstand the overload, repeated abuse may damage it.

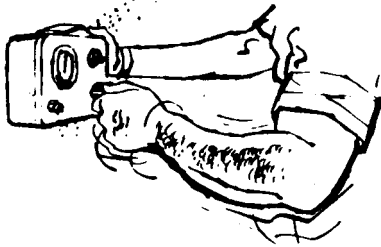
3. To decrease the leak rate, slowly turn the DECREASE valve knob counterclockwise until the instrument's pointer starts to move down scale. As the pointer approaches the desired leak rate, gradually close the DECREASE valve so that the pointer will stop at the desired leak rate. If the instrument pointer continues to go down scale, this is an indication that the DECREASE valve is not closed. Make sure the DECREASE valve is firmly closed.
- 
4. After increasing or decreasing the leak rate, be sure both valves are closed by turning each knob fully clockwise.
 5. After increasing or decreasing the leak rate and valves are firmly closed, wait approximately one minute for the leak rate to stabilize before calibrating your leak detector.

NOTE: *When the leak rate is being decreased, the refrigerant gas is allowed to escape through the Vent to atmosphere. During this operation it is best to remove the Leak Standard from the test area. If this is not possible, attach the VENT TUBING to the vent and lead the tubing out a window or to the floor.*

6. The Leak Standard is now ready for use.

APPLICATIONS

The Leak Standard may be used in several ways:

- ***To check the operation and sensitivity of the leak detector:*** The probe of the detector to be checked is moved past the PROBE FITTING of the Leak Standard, which is set at the maximum leak rate allowable for any single leak on the item being leak tested. If an adequate signal is obtained, the leak detector has sufficient sensitivity (or more) to detect this rate of leak.
- ***To determine size of leaks:*** If the Leak Standard is set so that the leak detector gives the same signal for the Leak Standard as for the leak, the Leak Standard then indicates the size of the leak.
- ***To extend the useful life of the sensing element of the leak detector:*** Users frequently replace the detector's sensing element long before the end of its useful life. A sensing element can be used until it no longer responds to the desired setting of the Leak Standard. Additionally, the Leak Standard permits use of the lowest possible heater current to provide adequate leak detector sensitivity. These practices increase sensor life and result in reduced maintenance and lower replacement costs.
- ***To simplify establishment of leak-rate specifications:*** The Leak Standard makes feasible the establishment of leak-rate specifications and provides a uniform standard for calibrating leak detectors at each location of product inspection. This assures agreement of all tests.
- ***To improve product quality:*** By calibrating leak detectors with the Leaks Standard, it is now possible to locate and repair all significant leaks, thus assuring high quality work.

OPERATIONAL PROCEDURE

CAUTION:

Never allow any grease or liquid to enter the LEAK CAPILLARY, as it may plug or alter its leak rate.

When the Leak Standard is not in use, it is recommended that the instrument pointer be set at half scale, and that the PROTECTIVE CAPS be placed over the VENT and LEAK CAPILLARY. This must be done in order to prevent plugging of the capillary.

When unit or system contains 100% R-12 / R-134a

With the Leak Standard prepared for use as described under PREPARATION FOR OPERATION on Page 5, proceed as follows:

1. Turn on your leak detector and allow it to warm-up for the time prescribed in the applicable leak detector instruction manual.

NOTE: *Before performing the following step, it is necessary to blow your breath lightly over the LEAK CAPILLARY on the Leak Standard — at a distance of about 15 inches. This will eliminate any refrigerant that may have accumulated around the LEAK CAPILLARY.*

2. Pass the tip of the leak detector probe past the PROBE fitting on the Leak Standard at a rate of about one inch per second, so that the tip of the probe just grazes the front circular edge of the PROBE fitting and passes across the center of the PROBE fitting. (See Fig. 4.) **DO NOT LET THE LEAK DETECTOR PROBE TOUCH THE GLASS CAPILLARY.** If probe is allowed to touch, **YOU MAY BREAK THE GLASS CAPILLARY.**

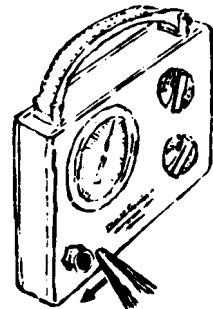

Fig. 4. Checking Sensitivity of Leak Detector

Type LS-20B Leak Standard

3. Repeat the above procedure, reducing or increasing the sensitivity of the leak detector each time, until the leak detector signal is adequate.
4. Replace the protective cap on the LEAK CAPILLARY and proceed to probe the suspected leak area, following the procedure outlined in the leak detector's instruction manual.

A leak that gives the same leak signal as the Leak Standard is the same size as indicated by the Leak Standard. A larger or smaller signal indicates a larger or smaller leak, respectively.

If it is desired to determine the size of any leak that is located, adjust the Leak Standard in 0.1 ounce increments (waiting approximately one minute after each change) until the signal caused by the Leak Standard is the same as that caused by the leak. The Leak Standard now indicates the size of the leak in question.

When unit or system contains less than 100% R-12 / R-134a

For this application the Leak Standard may be used to calibrate a leak detector; however, a leak from the vessel (such as a tank, pipe, or steam condenser), that produces the same leak signal as does the Leak Standard, will have a total leak rate that is approximately inversely proportional to the percent R-12 / R-134a in the enclosure.

Example: with 10% Refrigerant-12 used in the enclosure and a Leak Standard indication of 1.0 ounce per year, the leak rate is 1.0×10 , or 10 ounces per year.

PRINCIPLES OF OPERATION

The Type LS-20B Leak Standard is shown schematically in Fig.5; and operates as discussed below.

The filler tank provides a supply of R-12 / R-134a liquid under its own partial pressure.

The INCREASE valve controls the amount of refrigerant gas fed from the filler tank to the ballast tank, the leak-rate gage, and the leak capillary. The pressure in the system is maintained by the ballast tank. With the INCREASE and DECREASE valves closed, the system is practically in a static state, except for the minute amount of refrigerant gas that escapes through the leak capillary.

The DECREASE valve provides a means of decreasing the pressure built up in the system. With the DECREASE valve opened, refrigerant gas is allowed to escape through the VENT opening on the front of the Leak Standard.

The rate of refrigerant gas escaping through the leak capillary is a function of the pressure in the system and is indicated on the LEAK RATE gage in ounces per year.

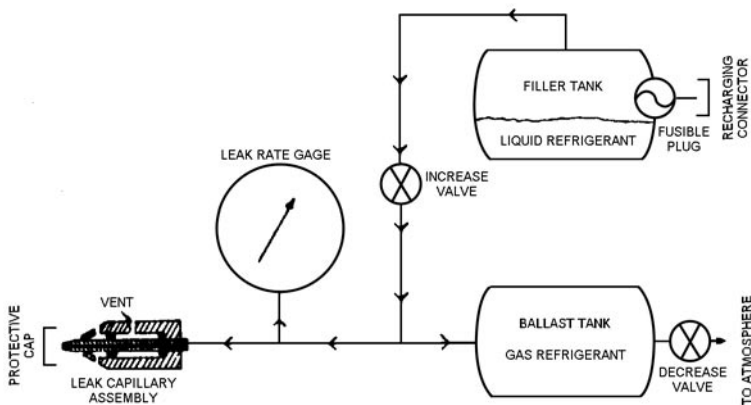

Fig. 5. Type LS-20B Schematic Diagram

MAINTENANCE

REFILLING LEAK STANDARD

When the supply of liquid refrigerant in the TANK is exhausted, the Leak Standard will no longer respond to the opening of the INCREASE valve, which indicates refilling is needed. Please read through all the steps before proceeding.

A 15-ounce can of R-12 / R-134a refrigerant in a “Can-O-Gas” or “Charg-A-Can” container needs to be procured through your local refrigeration supply house.

1. Remove screw from center of back cover of Leak Standard, and then remove and set aside back cover.
2. Remove center section of Leak Standard (the center section has the handle attached to it), and lay the center section on its side.

WARNING!

It is recommended that safety glasses with non-perforated side shields be worn during this refilling procedure, as liquid refrigerant can be damaging to the eyes.

In Steps 3, 4, and 5 below, some refrigerant gas may leak out while performing these steps; therefore, avoid coming in contact with the gas.



CAUTION:

In order to assure that no dirt or other contamination gets into the LS-20B during refilling operations, make sure that all couplings and valves are clean.

NOTE: *Because refrigerant gas will escape during the refilling operation, this procedure should be performed outside the testing area to avoid contaminating the air in the area.*

3. Connect the can valve (supplied with the Leak Standard) to the can of refrigerant in the following manner:

- a. When using a plain-top can of refrigerant, use the valve and prong clamp only; and then:
 1. Force the clamp onto the can closure cap until all three prongs are securely engaged under the closure cap lid.
 2. Make sure that the valve is closed; then, thread the valve clockwise into the clamp until the can is pierced.
- b. When using a threaded-top can of refrigerant, use the valve, clamp, and safety sleeve; and then:
 1. Force the clamp onto the can closure cap until all three prongs are securely engaged under the closure cap lid.

NOTE: *Always use the safety sleeve when opening a can with a threaded top. Without this sleeve, enough force can be applied to distort the threaded can top causing it to leak.*

2. Make sure that the valve is closed; then, install the safety sleeve on the valve inlet thread and screw the valve into the clamp as far as the safety sleeve will allow. At this point the can is pierced.
4. Using the wrench (supplied), remove the fusible plug from the rear of the upper TANK in Leak Standard (some refrigerant gas may leak out at this time), and insert the coupler (supplied). Slightly tighten the coupler with the wrench.
5. With Leak Standard in its upright position, invert can of refrigerant and attach it to the coupler. Finger tighten the coupler.
6. Support the can of refrigerant — to prevent the unit from tipping over — by placing the edge of the instrument's center section (which was removed in Step 2) under the knurled part (largest diameter) of the coupler (see Fig. 6).
7. With the INCREASE valve closed, open the valve on the can of refrigerant several turns. If the instrument's LEAK RATE gage pointer starts to go up scale, this indicates that the INCREASE valve is not closed. Make sure the INCREASE valve is firmly closed.

Type LS-20B Leak Standard

8. Open DECREASE valve one and one-half turns (counterclockwise).
9. **IMPORTANT:** This step pertains to the actual charging of the Leak Standard (which requires approximately five seconds). It **MUST** be read thoroughly before proceeding. It is normal for some gas to escape during this procedure.

With one hand on the INCREASE valve, and the other supporting the instrument, open the INCREASE valve slightly (turning counterclockwise) and observe that the instrument's LEAK RATE gage pointer should begin to move upscale. When the pointer reaches mid scale, or after 5 seconds, whichever occurs first, firmly close the INCREASE valve (clockwise).

10. Close valve on refrigerant can.
11. Close DECREASE valve slowly. If the gage pointer goes up scale, open DECREASE valve fully counterclockwise and check to make sure that the INCREASE valve is fully closed (clockwise). Again close DECREASE valve slowly. If pointer still goes up scale, open DECREASE valve and wait 10 seconds. Repeat procedure until pointer does not go up scale when DECREASE valve is closed.

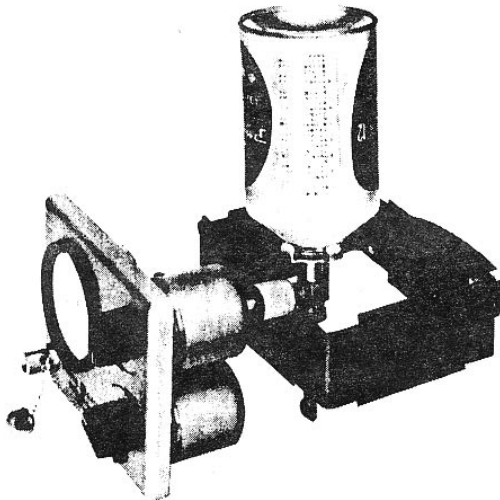

Fig. 6. Refilling Leak Standard

12. First remove can of refrigerant from coupler (by turning knurled sleeve with fingers), and then remove coupler from upper tank (using the wrench). Immediately replace plug in upper tank and firmly tighten while holding the upper tank by hand. The filler fitting on the upper tank contains a ball check that may leak slightly until plug is replaced.
13. Reassemble the center section and back cover to the front cover, securing them with the screw removed in Step 1, being careful not to overtighten the screw.
14. If the Leak Standard is to be used immediately, then reset unit to desired leak rate (see Steps 1 and 2 in the PREPARATION FOR OPERATION section); otherwise set it to approximately half scale by slowly opening the INCREASE valve until the desired setting is obtained, and then close the valve firmly (clockwise). If the instrument pointer goes down scale, this is an indication that DECREASE valve is not closed. Make sure the DECREASE valve is firmly closed.

REPLACING LEAK CAPILLARY

If the leak capillary in the PROBE fitting needs to be replaced, proceed as follows:

1. Make sure the INCREASE valve is firmly closed.
2. Open the DECREASE valve.
3. Remove the back cover and center section of the Leak Standard as described in section REFILLING LEAK STANDARD on Page 10.
4. Use open-end wrenches to hold the brass capillary-tube housing and remove the PROBE fitting. On later units, also remove ring nut using tool supplied.
5. Slide the leak capillary out of the brass housing.
6. Insert the new leak capillary and O-rings (make sure O-rings are clean).
7. Replace parts in reverse order and firmly tighten together, being careful not to overtighten.

APPLICATION DATA

EQUIVALENT LEAK RATES

In the following table all numbers on the same line (reading across) are approximate leak values at the same pressure through the same physical leak and for all practical purposes may be used interchangeably.

REFRIGERANT R-12 LEAKAGE						
cc/sec. (1)	Cubic in. per day	Micron Cu. Ft. per hr. of air	LUSEC (Micron Liter/sec. of air)	Ounces per yr.	Time for 1 lb. to Leak (2)	Immersion Test Bubble Time (3)
1.8×10^{-2}	94.6	1720	13.7	100	0.16 yr.	1.3 sec.
1.8×10^{-3}	9.46	172	1.37	10	1.6 yrs.	13.3 sec.
1.8×10^{-4}	0.946	17.2	0.14	1	16 yrs.	145 sec.
9×10^{-5} (4)	0.473	8.5	0.07	0.5	32 yrs.	290 sec. (4)
1.8×10^{-5}	0.0946	1.72	1.4×10^{-2}	0.1	160 yrs.	24 min.

- (1) Standard conditions are 14.7 psia and 77°F or 760,000 microns absolute and 25°C.
- (2) Through any one leak at the same pressure, the volume of leakage will be approximately the same for R-12, R-22, R-114, and air or any mixture.
- (3) "Bubble time" is the interval from one bubble to the next. Bubble time varies widely with size of bubble. Time is shown for leak directed through a tube (3/32" I.D. and 5/32" O.D.) the end of which points downward at 45° and is 1/4" under the water surface. Starred (*) items are based on experimental data. The balance of the data is extrapolated.
- (4) Experimental data indicates that no visible water will leak when dry air at the same pressure will leak at the rate of 1.8×10^{-3} cc/sec. — probably due to surface tension. To be on the safe side it is believed that enclosures for containing liquids (water, oil, etc.) should have no leaks at rated pressure that will pass more than 1×10^{-4} std. cc. of air per second.

NOTE: *Refrigerant R-12 leakage is approximately 1/3 greater than air through the same leak. Helium leakage in volume is about the same as air for leaks of 1×10^{-6} cc/sec. and larger. For leaks smaller than 1×10^{-6} the volume of helium leakage will be somewhat greater than air through the same physical leak at the same pressure difference.*

Typical accuracy curves for
Leak Standard LS-20B

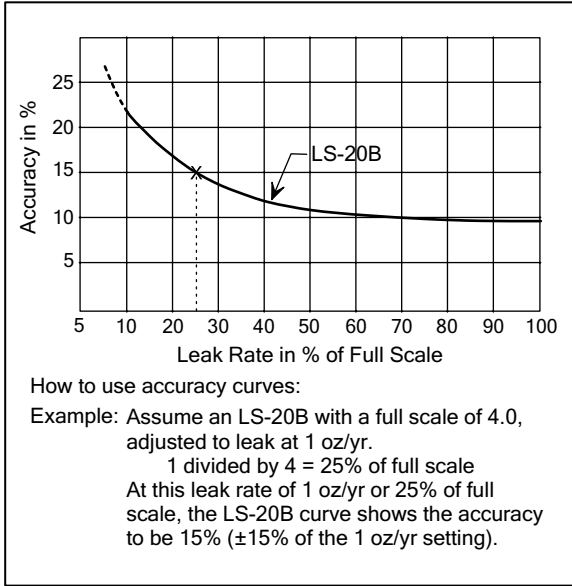

REFRIGERANT R-134a LEAKAGE			
cc/sec	Cubic in per day	Ounces per yr.	Time for 1 lb. to leak
1.8×10^{-2}	103	92	0.17 yr.
1.8×10^{-3}	10.3	9.2	1.7 yrs.
1.8×10^{-4}	1.03	0.92	17 yrs.
9×10^{-5}	0.515	0.46	34 yrs.
1.8×10^{-5}	0.103	0.092	170 yrs.

RENEWAL PARTS

Renewal parts should be ordered through Bacharach, Inc. When ordering parts, a description of the part and its complete catalog number should be supplied.

Description	Part No.	
	R-12	R-134a
Cap and Chain	3015-1283	3015-1283
Connector Tube Assembly	3015-1333	3015-1333
Pressure Gauge 0 to 10	3015-2357	3015-1443
Pressure Gauge 0 to 3	3015-2387	3015-1448
Kit, Maintenance	3015-1503	3015-1498
Fusible Plug	3015-1229	3015-1229
O-Ring (to seal connector tube to tanks)	3015-2332	3015-2332
Tank, Upper	3015-1217	3015-1217
Tank, Lower	3015-1264	3015-1264
Flat Washer (at pressure gage inlet)	3015-1338	3015-1338

Capillary Kit (for replacement)

Leak Rate (cc/ sec)	Part No.
10×10^{-6}	3015-1548
3×10^{-5}	3015-1558
10×10^{-5}	3015-1568
3×10^{-4}	3015-1578
10×10^{-4}	3015-1588
3×10^{-3}	3015-1598

SERVICE CENTERS

United States

California

7281 Garden Grove Blvd.,
Suite H
Garden Grove, CA 92841
Phone: 714-895-0050
Fax: 714-895-7950
E-mail: calservice@bacharach-inc.com

Georgia

2 Dart Rd.
Newnan, GA 30265
Phone: 800-850-0044
Fax: 678-423-2479
E-mail: kayes@bacharach-inc.com

Indiana

8618 Louisiana Place
Merrillville, IN 46410
Phone: 219-736-6178
Fax: 219-736-6269
E-mail: indservice@bacharach-inc.com

New Jersey

7300 Industrial Park
Rte. 130, Bldg. 22
Pennsauken, NJ 08110
Phone: 856-665-6176
Fax: 856-665-6661
E-mail: njservice@bacharach-inc.com

Pennsylvania

621 Hunt Valley Circle
New Kensington, PA 15068
Phone: 724-334-5051
Fax: 724-334-5723
E-mail: help@bacharach-inc.com

Texas

5151 Mitchelldale, B-4
Houston, TX 77092
Phone: 713-683-8141
Fax: 713-683-9437
E-mail: txservice@bacharach-inc.com

Canada

Bacharach of Canada, Inc.
250 Shields Court Unit #3
Markham, Ontario L3R 9W7 Canada
Phone: 905-470-8985
Fax: 905-470-8963
E-mail: bachcan@idirect.com

México

Bacharach de México
Playa Regatas No. 473 Tercer Piso
Col. Militar Marte
Delegación Iztacalco, 08830
México D.F.
México
Phones: 011-5255-5634-7740
011-5255-5634-7741
FAX: 011-5255-5634-7738
E-mail: bacharach@prodigy.net.mx

Europe

European Headquarters

Bacharach Instruments
Sovereign House, Queensway
Leamington Spa
Warwickshire CV31 3JR
England
Phone: +44-1926-338111
Fax: +44-1926-338110
E-mail: sales@bacharach-europe.com

Sales / Service Center - Denmark

Bacharach Instruments Int'l
P.O. Box 44
39 Lindegade
DK 6070 Christiansfeld
Denmark
Phone: +45-74-563171
Fax: +45-74-563178
E-mail: mail@bacharach.dk

Type LS-20B Leak Standard

NOTES:

NOTES:



Bacharach, Inc.
2 Dart Road, Newnan GA 30265
Ph: 678-423-2481 • Fax: 678-423-2479
Website: www.bacharach-inc.com • E-mail: help@bacharach-inc.com